

Specification For Color Series

HPL-H40WX1C0

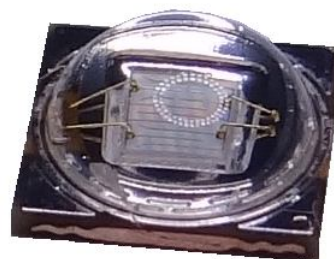

Features

- Dimension : 4.0mm(L)×4.0mm(W)
- High Radiant Flux type
- All Metal Design Cu Substrate with Silicone Lens
- The InGaN or AlInGaP Chip inside
- Low thermal resistance

Applications

- Signal lighting
- Interior & exterior automotive lighting
- Decorating and entertainment lighting
- Grow lighting

5F, No 173-8, Yung-Fon Road, Tu-Cheng District, New Taipei City, Taiwan, R.O.C.
TEL: +886-2-8262-8886 FAX : +886-2-8262-8885

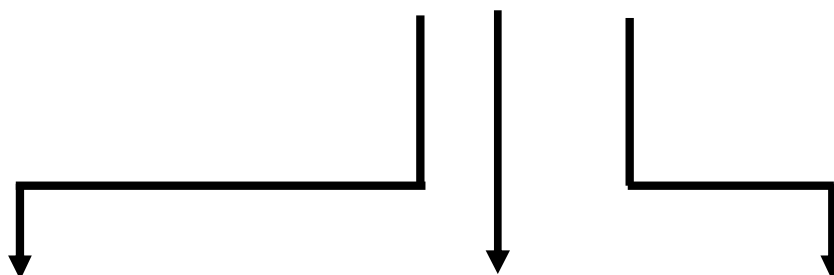

Table of Contents

General Information3
Part Number Matrix4
Absolute Maximum Ratings5
Initial Electrical/Optical Characteristics6
Forward Voltage6
Reverse Current6
Luminous Flux or Radiant Flux7
Dominate Wavelength or Peak Wavelength7
Typical Radiation Pattern8
Bin Code List for Reference9
Hue Bin Specification for Red, Green, Blue, Amber, Orange, Royal Blue11
Part Number Formation12
Characteristic Diagram13
Outline Dimension15
Pad Configuration15
Recommended Solder Pattern17
Shipping Package Style18
Qualification Reliability Testing25
Recommended Solder Profile26

General Information

HPL - H40WX1C0



Lens & Assembly Type-
W : 140° Lens
Z : 140° Lens With Star

X : Color-
R: Red
G: Green
B: Blue
A: Amber
O: Orange
D: Royal Blue
H: Deep Red

Power-
C : 3W

Part Number Matrix

Color \ Type	140° Lens	140° Lens & Star
Red	HPL-H40WR1C0	HPL-H40ZR1C0
Green	HPL-H40WG1C0	HPL-H40ZG1C0
Blue	HPL-H40WB1C0	HPL-H40ZB1C0
Amber	HPL-H40WA1C0	HPL-H40ZA1C0
Orange	HPL-H40WO1C0	HPL-H40ZO1C0
Royal Blue	HPL-H40WD1C0	HPL-H40ZD1C0
Deep Red	HPL-H40WH1C0	HPL-H40ZH1C0

Handling precaution



Do not poke the silicone encapsulant with sharp object



Do not stack assembled PCB



Do not hold the LED with hand



Do not touch and press the silicone encapsulant

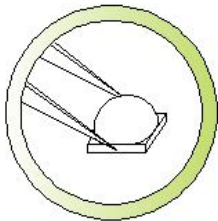

Hold the LED only by the metal substrate

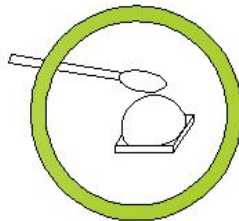

Clean the silicone surface with cotton bud with minimal pressure

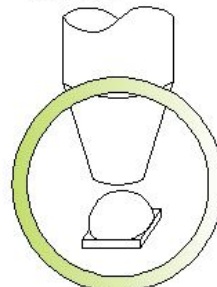

Use pick and place nozzle per recommendation in datasheet

Absolute Maximum Ratings

(T_j=25°C)

Parameter	Symbol	Rating	Unit
Power Dissipation	Red	2.1	W
	Green	2.8	
	Blue	2.8	
	Amber	2.1	
	Orange	2.1	
	Royal Blue	2.8	
	Deep Red	2.1	
Forward Current	I _F	700	mA
Forward Pulse Current (1/10 Duty Cycle, 400msec Pulse Width)	I _{FP}	1000	mA
Thermal Resistance, Junction-Case	R _{th, J-C1}	10	°C/W
Reverse Voltage	V _R	5	V
LED Junction Temperature	T _j	125	°C
Operating Temperature Range	T _{opr}	-40°C to + 80°C	
Storage Temperature Range	T _{stg}	-40°C to + 120°C	
Soldering Condition	T _{sol}	260°C For 5 Seconds	

Note: 1. The thermal resistance value is measured with MCPCB (Star).

Initial Electrical/Optical Characteristics

● Forward Voltage

(T_j=25°C)

Color	Forward Voltage					
	Symbol	MIN.	TYP.	MAX.	Test Condition	Unit
Red→R	V _F	1.83	2.50	3.03	I _F = 700mA	V
Green→G	V _F	3.03	3.80	4.23	I _F = 700mA	V
Blue→B	V _F	3.03	3.80	4.23	I _F = 700mA	V
Amber→A	V _F	1.83	2.50	3.03	I _F = 700mA	V
Orange→O	V _F	1.83	2.50	3.03	I _F = 700mA	V
Royal Blue→D	V _F	3.03	3.80	4.23	I _F = 700mA	V
Deep Red →H	V _F	1.83	2.50	3.03	I _F = 700mA	V

● Reverse Current

(T_j=25°C)

Color	Reverse Current					
	Symbol	MIN.	TYP.	MAX.	Test Condition	Unit
Red→R	I _R	-	-	100	V _R = 5V	μA
Green→G	I _R	-	-	100	V _R = 5V	μA
Blue→B	I _R	-	-	100	V _R = 5V	μA
Amber→A	I _R	-	-	100	V _R = 5V	μA
Orange→O	I _R	-	-	100	V _R = 5V	μA
Royal Blue→D	I _R	-	-	100	V _R = 5V	μA
Deep Red →H	I _R	-	-	100	V _R = 5V	μA

● **Luminous Flux or Radiant Flux** (T_j=25°C)

Color	Luminous Flux or Radiant Flux					
	Symbol	MIN.	TYP.	MAX.	Test Condition	Unit
Red→R	Φ _v	-	100	-	I _F = 700mA	lm
Green→G	Φ _v	-	130	-	I _F = 700mA	lm
Blue→B	Φ _v	-	30	-	I _F = 700mA	lm
Amber→A	Φ _v	-	70	-	I _F = 700mA	lm
Orange→O	Φ _v	-	100	-	I _F = 700mA	lm
Royal Blue→D	Φ _e	-	680	-	I _F = 700mA	mW
Deep Red →H	Φ _e	-	500	-	I _F = 700mA	mW

● **Dominate Wavelength or Peak Wavelength** (T_j=25°C)

Color	Dominate Wavelength or Peak Wavelength					
	Symbol	MIN.	TYP.	MAX.	Test Condition	Unit
Red→R	λ _d	620	-	630	I _F = 700mA	nm
Green→G	λ _d	520	-	535	I _F = 700mA	nm
Blue→B	λ _d	460	-	475	I _F = 700mA	nm
Amber→A	λ _d	585	-	595	I _F = 700mA	nm
Orange→O	λ _d	610	-	620	I _F = 700mA	nm
Royal Blue→D	λ _p	440	-	460	I _F = 700mA	nm
Deep Red →H	λ _p	650	-	670	I _F = 700mA	nm

Note: Royal Blue and Deep Red LEDs are binned by Radiant Flux and Peak Wavelength

- **Typical Radiation Pattern**

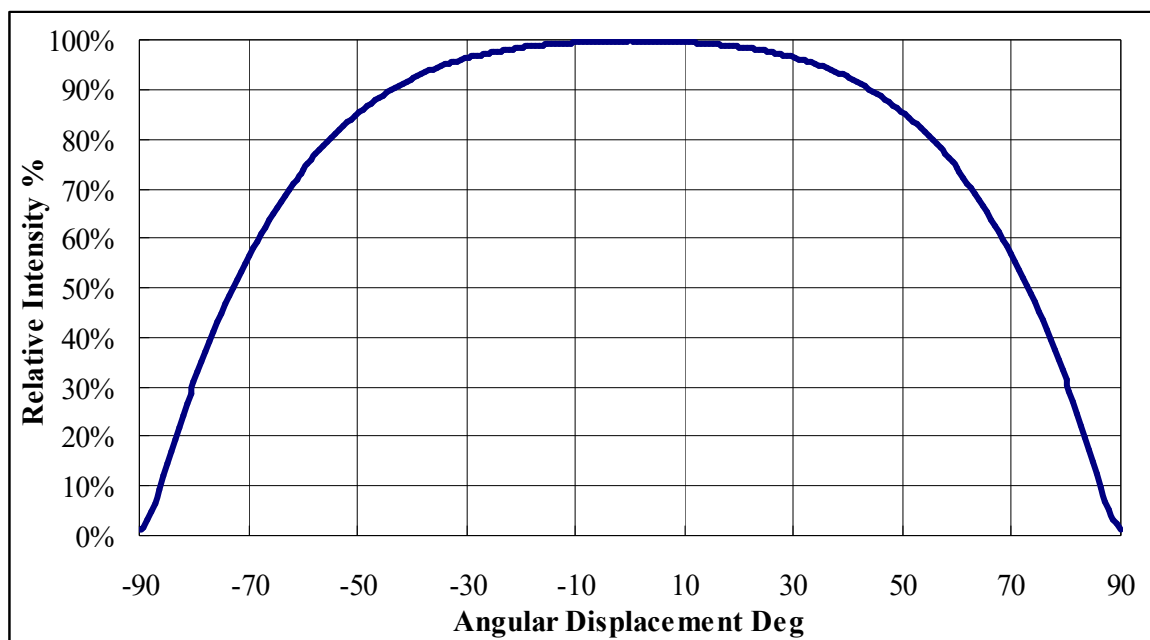

Fig. Typical Representative Spatial Radiation Pattern : 140 degree

● **Bin Code List for Reference**

(T_j=25°C)

Item	Bin Code	Symbol	Condition	Min.	Max.	Unit
Forward Voltage ¹	C	V _F	I _F = 700 [mA]	1.83	2.07	V
	D			2.07	2.31	
	E			2.31	2.55	
	F			2.55	2.79	
	G			2.79	3.03	
	H			3.03	3.27	
	J			3.27	3.51	
	K			3.51	3.75	
	L			3.75	3.99	
	M			3.99	4.23	
Luminous Flux ²	C	Φ _V	I _F = 700 [mA]	13.9	18.1	lm
	D			18.1	23.5	
	E			23.5	30	
	F			30	40	
	G			40	50	
	H			50	60	
	J			60	70	
	K			70	80	
	L			80	90	
	M			90	100	
	N			100	120	
	P			120	140	
	Q			140	160	
	R			160	180	
S	180	200				

Radiant Flux²	D	Φ_e	$I_F = 700$ [mA]	350	425	mW
	E			425	500	
	F			500	600	
	G			600	700	
	H			700	800	
	J			800	900	

Note: 1. Forward voltage measurement allowance is $\pm 0.1V$.

2. Luminous Flux or Radiant Flux measurement allowance is $\pm 10\%$.

- Hue Bin Specification for Red, Green, Blue, Amber, Orange, Royal Blue

Name	Code	λ Min (nm)	λ Max (nm)
Blue	B1	460	465
	B2	465	470
	B3	470	475
Green	G2	520	525
	G3	525	530
	G4	530	535
Amber	A2	587	589.5
	A4	589.5	592
	A6	592	594.5
Red & Orange	R2	610	615
	R3	615	620
	R4	620	625
	R5	625	630
Royal Blue	D0	440	445
	D1	445	450
	D2	450	455

Note: Wavelength measurement allowance is ± 2 nm

Part Number Formation

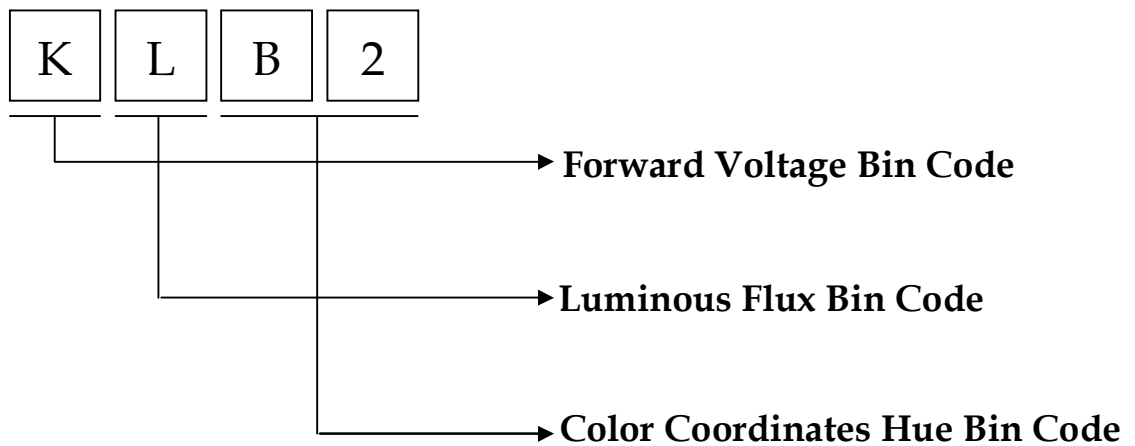
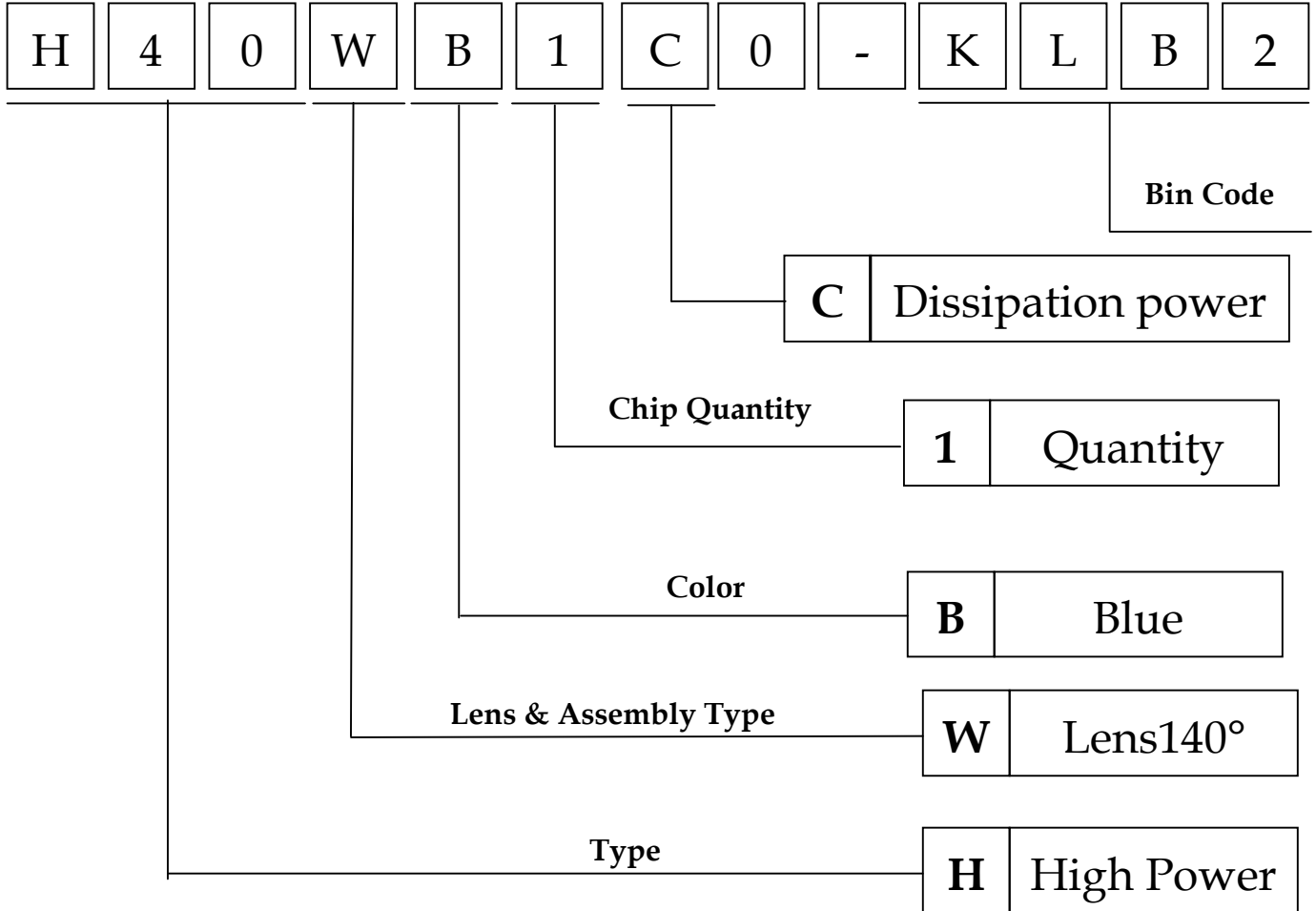

Characteristic Diagram

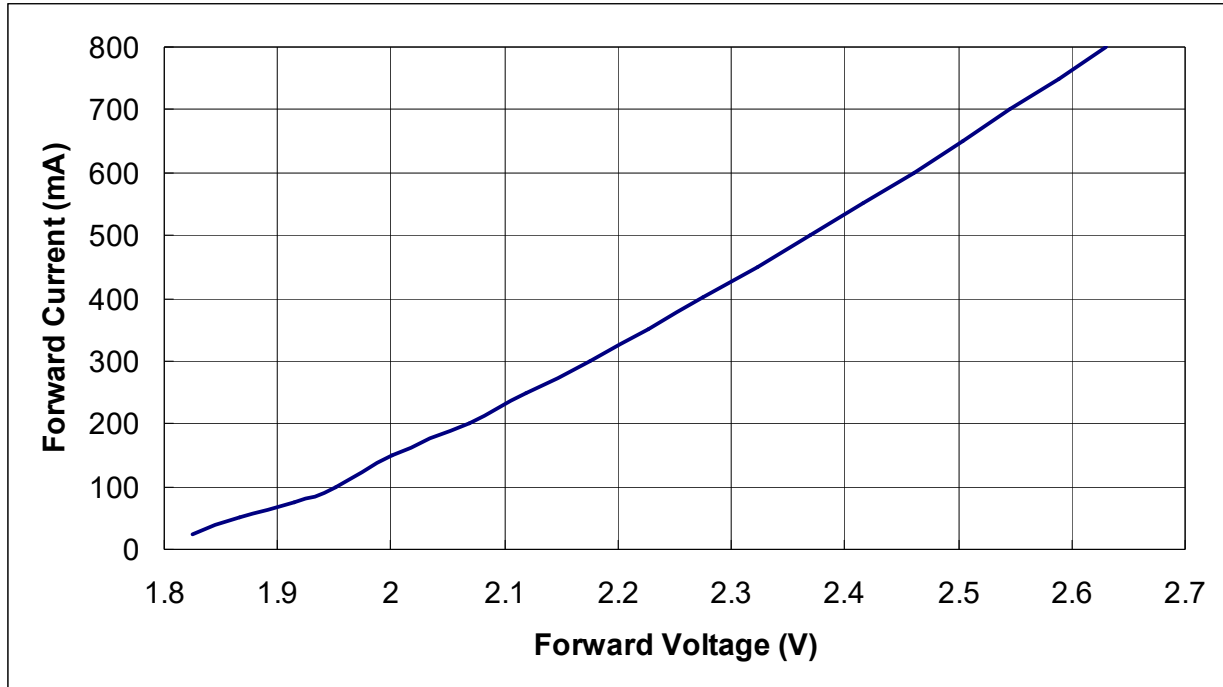

Fig. Forward Current vs. Forward Voltage: Red/Amber/Orange/Deep Red color.

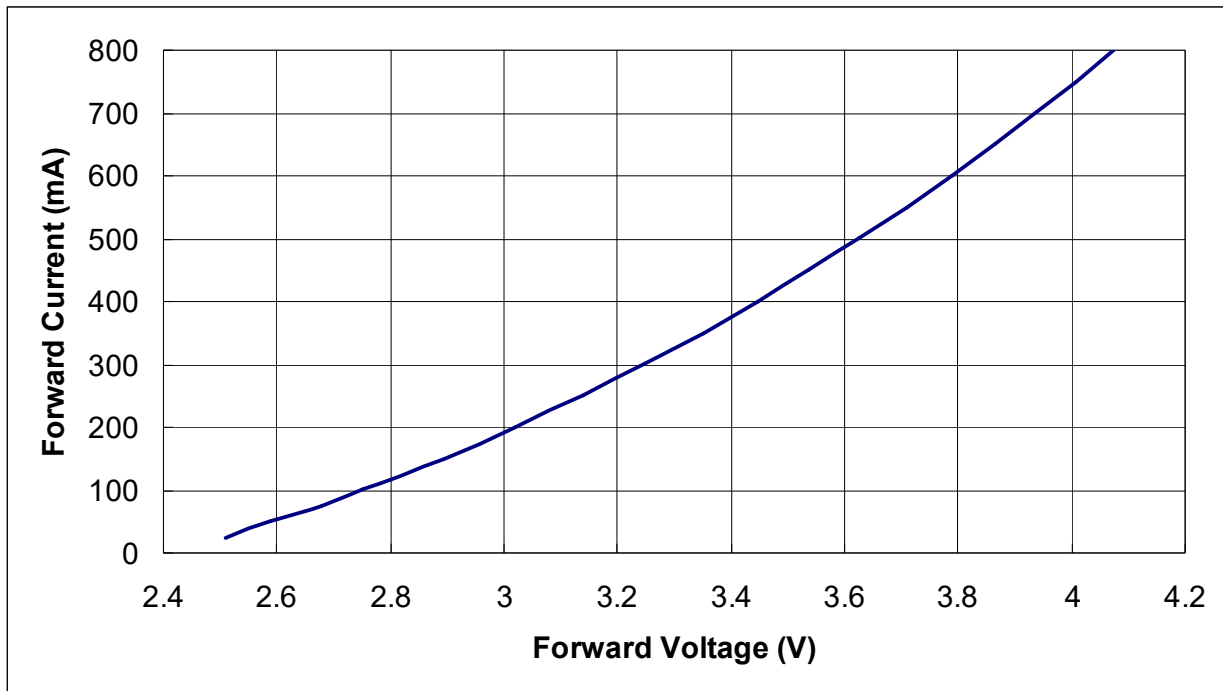

Fig. Forward Current vs. Forward Voltage: Blue/ Green /Royal Blue color.

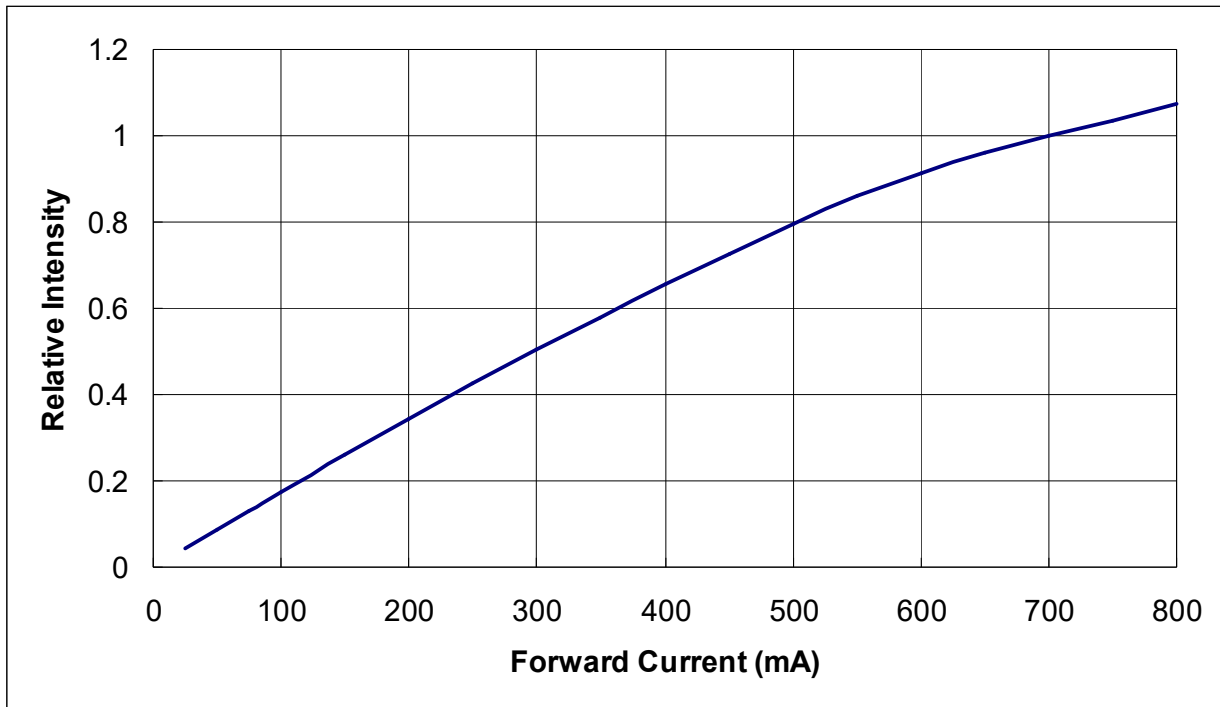

Fig. Relative Intensity vs. Forward Current.

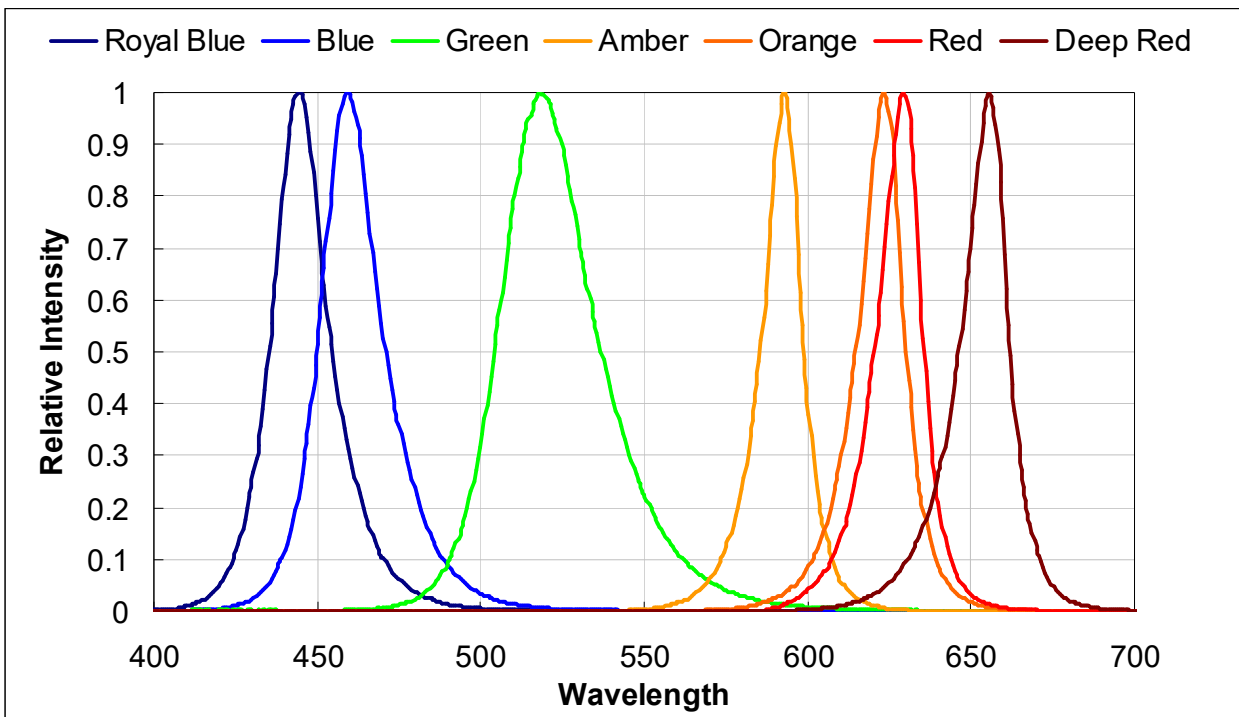

Fig. Relative Intensity vs. Wavelength: Single Color.

Outline Dimension

Unit : mm

HPL-H40WX1C0

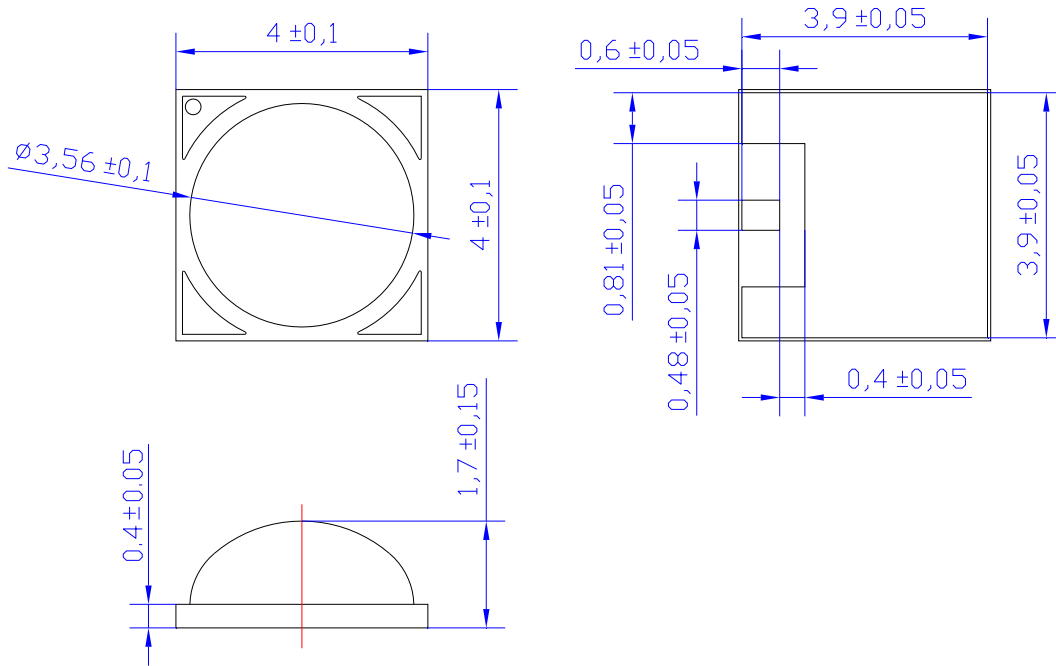
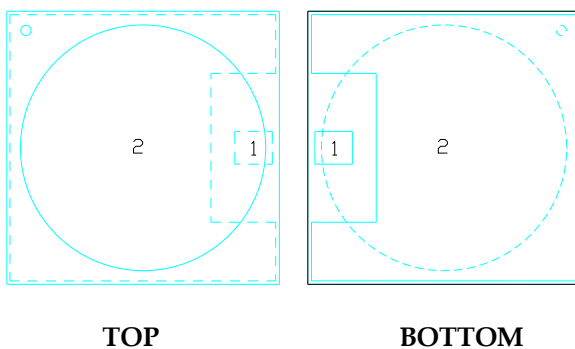

Fig. Package Outline Drawing.

Pad Configuration



PAD	Function
1	Cathode
2	Anode、Thermal

Fig8. Pad configuration.

Note: Please don't put conductive material on the top surface of LEDs.

HPL-H40ZX1C0

Unit : mm

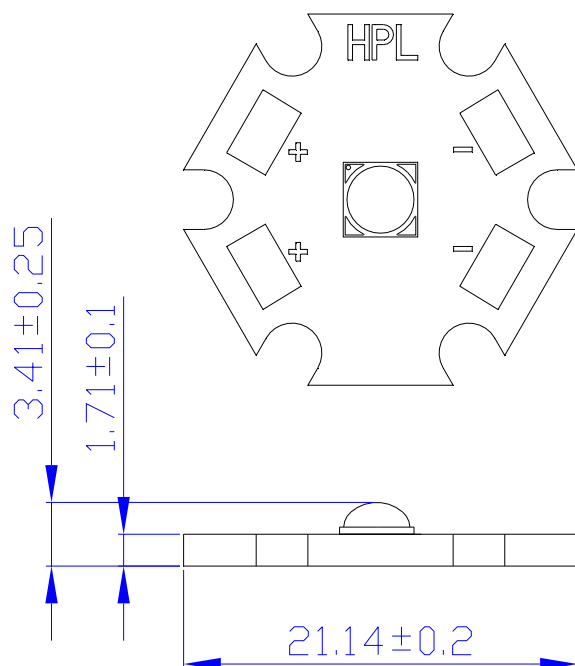
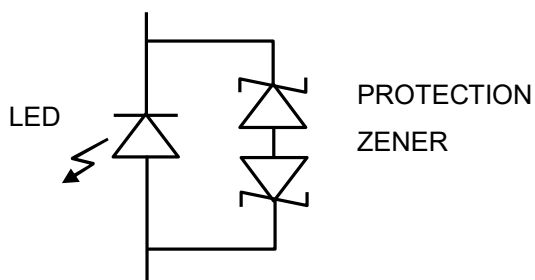

Fig. Assembly Outline Drawing.

PROTECTION CIRCUIT



Recommended Solder Pattern

Unit : mm

Tolerance ± 0.05

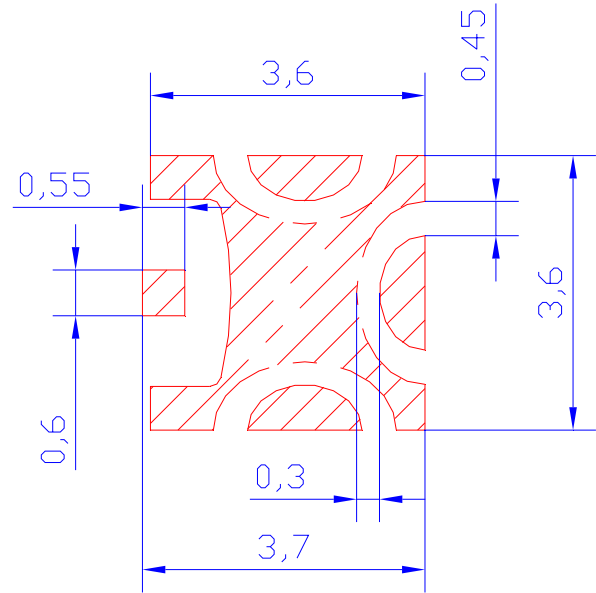
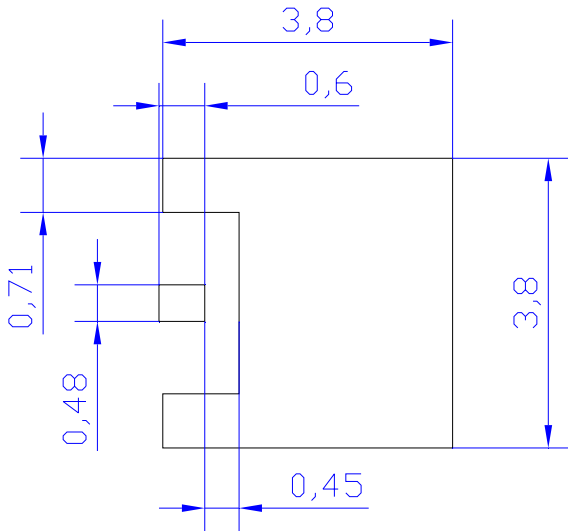

MCPCB LAYOUT

SOLDER MASK

Fig. Solder Pad Layout.

Shipping Package Style

Tapping Dimension Packaging Specification

- Moisture proof bag.
- 1 Reel/bag.
- Q'ty: 1000(MAX)/Reel

Unit : mm

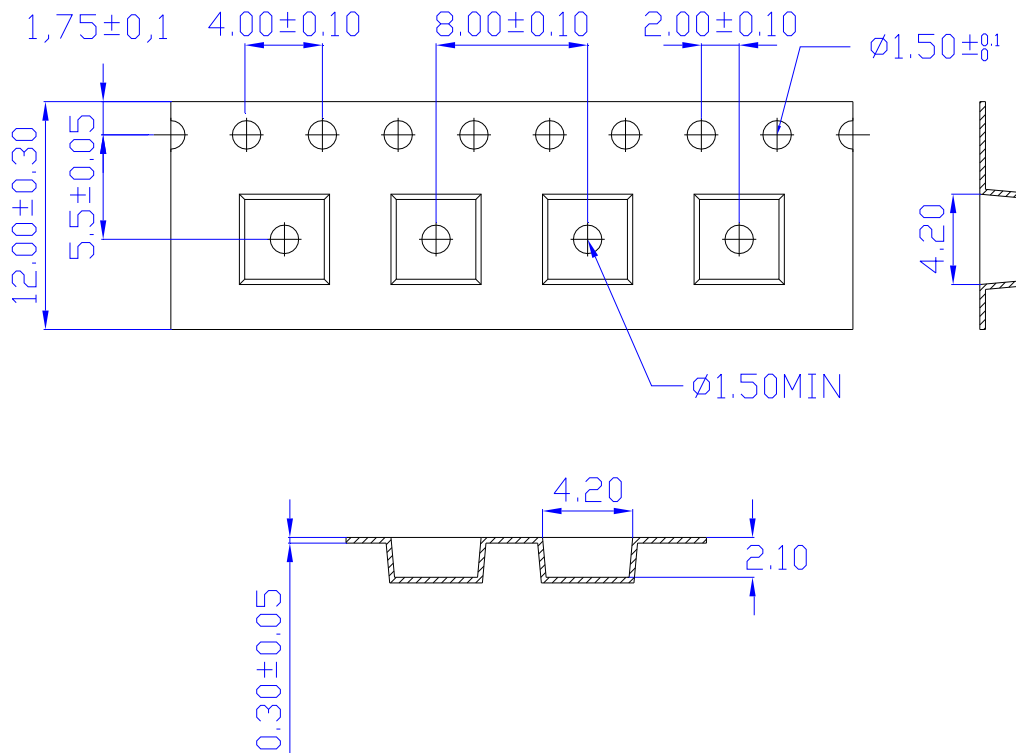

Package

Box Type	Dimension (mm)	Reel/Box	140°Lens Type (Pcs)
Small Box(S)	230x85x265	5 Reel/Box	5000
Middle Box(M)	470x265x270	30 Reel/Box	30000
Large Box(L)	470x435x270	50 Reel/Box	50000

Reel Packaging :

Reel Part :

Unit : mm

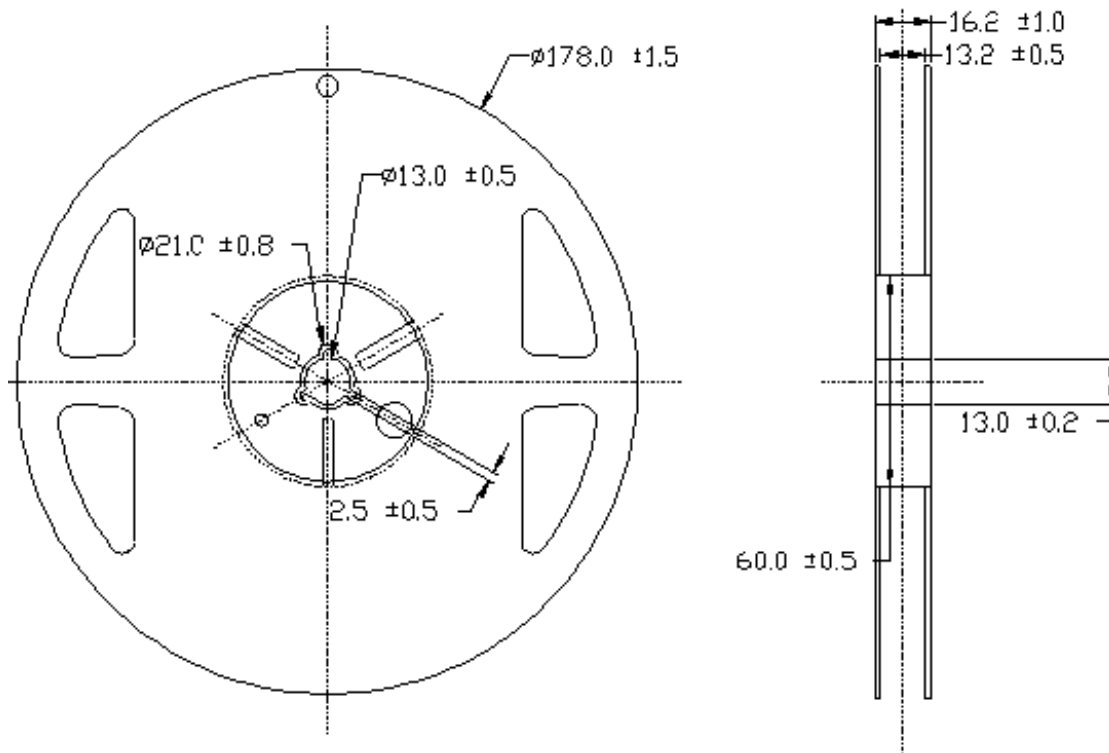

Anti Statistic Bag :

Unit : mm

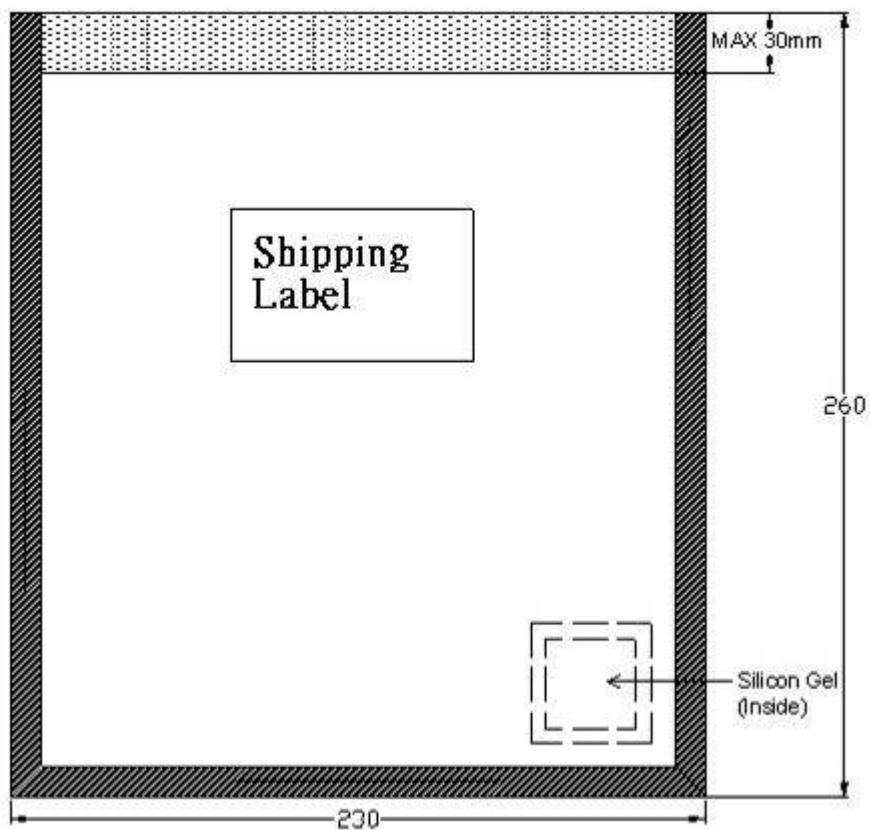

Small Box

Unit : mm

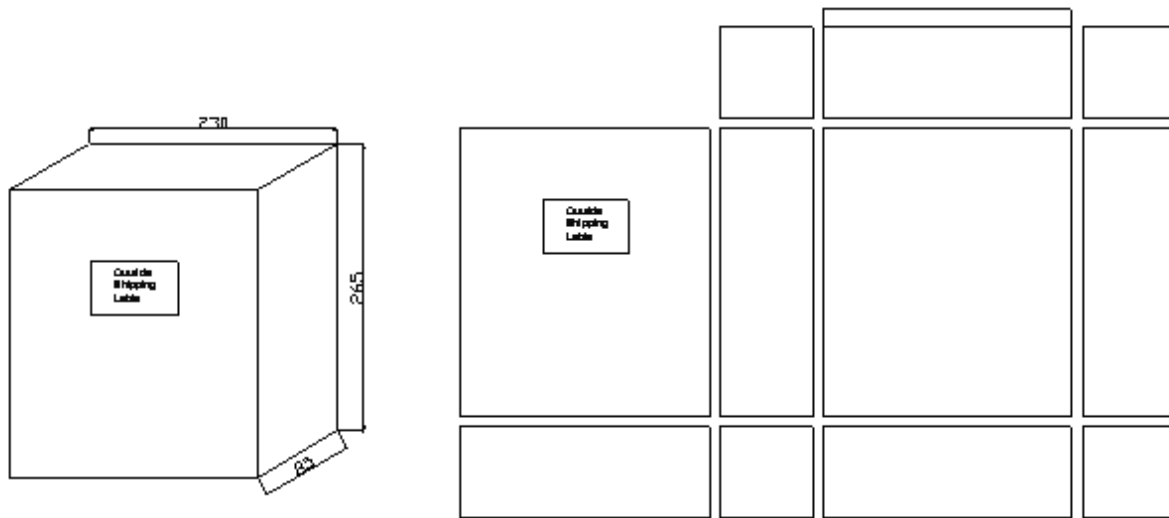

Middle Box

Unit : mm

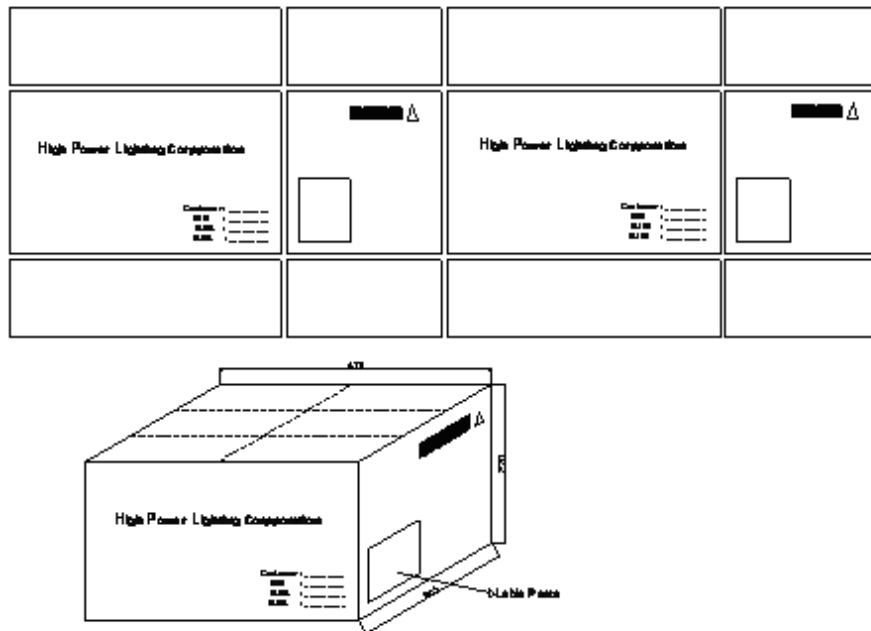

Large Box

Unit : mm

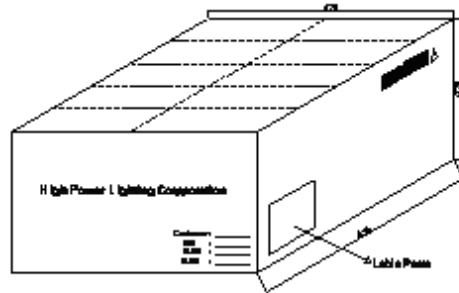
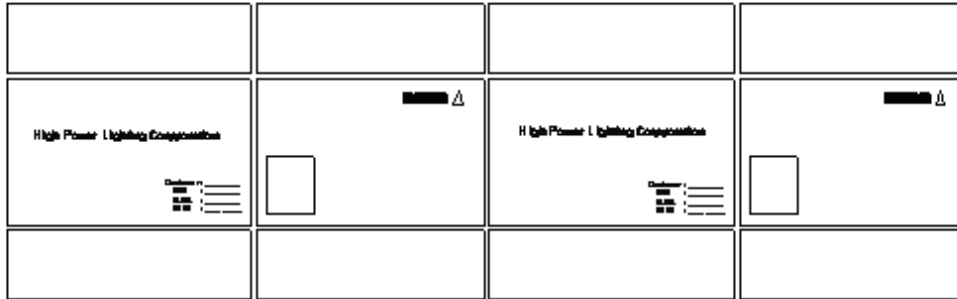

Label Formation

70mm

Unit : mm



40mm

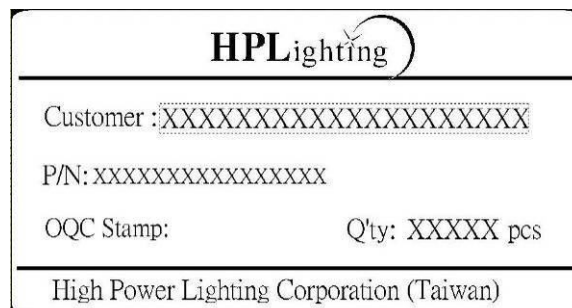

**Package
Large Box**

Unit : mm

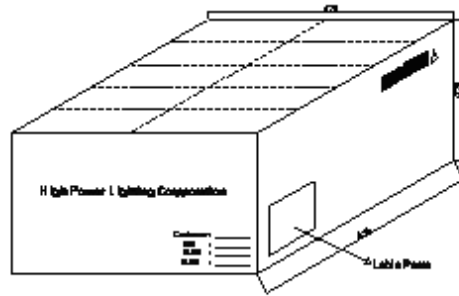
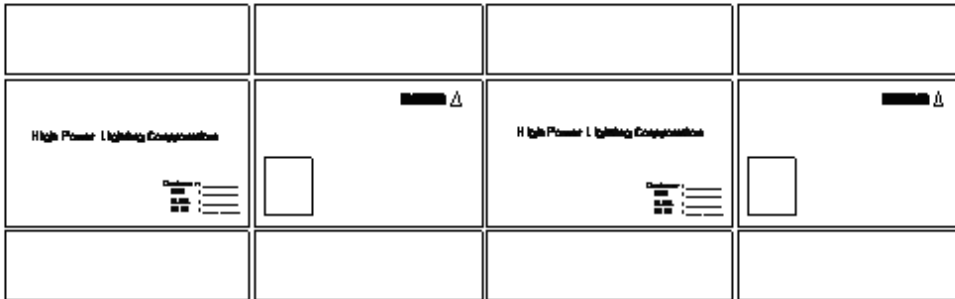

Label Formation

70mm

Unit : mm

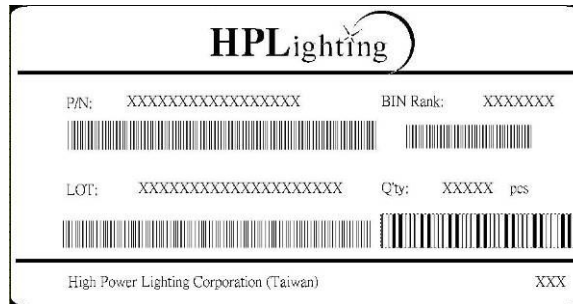

40mm

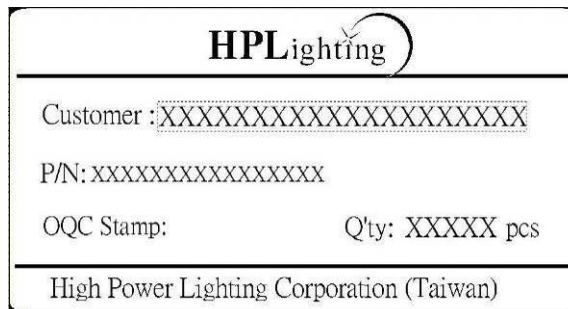

Qualification Reliability Testing

Classification	Test Item	Test conditions	Reference Standard
Endurance Test	Operation Life	$I_F = 700\text{mA}$ $T_a = 25^\circ\text{C}$ Test Duration = 1000hrs	MIL-STD-750: 1026 MIL-STD-883: 1005 JIS C 7021: B-1
	High Temperature High Humidity Storage	$T_a = 85\pm 5^\circ\text{C}$ RH = 85±5% Test Duration = 1000hrs	MIL-STD-202: 103B JIS C 7021: B-11
	High Temperature Storage	$T_a = 105\pm 5^\circ\text{C}$ Test Duration = 1000hrs	MIL-STD-202: 1008 JIS C 7021: B10
	Low Temperature Storage	$T_a = -40\pm 5^\circ\text{C}$ Test Duration = 1000hrs	JIS C 7021: B-12
Environmental Test	Temperature Cycling	$-30^\circ\text{C} \sim 25^\circ\text{C} \sim 105^\circ\text{C} \sim 25^\circ\text{C}$ 30min 5min 30min 5min Test Duration = 10 cycle	MIL-STD-202: 107D MIL-STD-750: 1051 MIL-STD-883: 1010 JIS C 7021: A-4
	Thermal Shock	$-30\pm 5^\circ\text{C} \sim 105\pm 5^\circ\text{C}$ 30min 30min Test Duration = 10 cycle	MIL-STD-202: 107D MIL-STD-750: 1051 MIL-STD-883: 1011
	Solder Resistance	$T_{\text{sol}} = 260\pm 5^\circ\text{C}$ Dwell Time = 10sec	MIL-STD-202: 210A MIL-STD-750: 2031 JIS C 7021: A-1

Measuring Items	Symbol	Measuring Conditions	Failure Criteria
Forward voltage	V_F	$I_F = 700\text{mA}$	V_F shift > 10%
Luminous	$I_v\%$	$I_F = 700\text{mA}$	$I_v\%$ shift > 10%

Recommended Solder profile

Soldering Recommended soldering conditions:

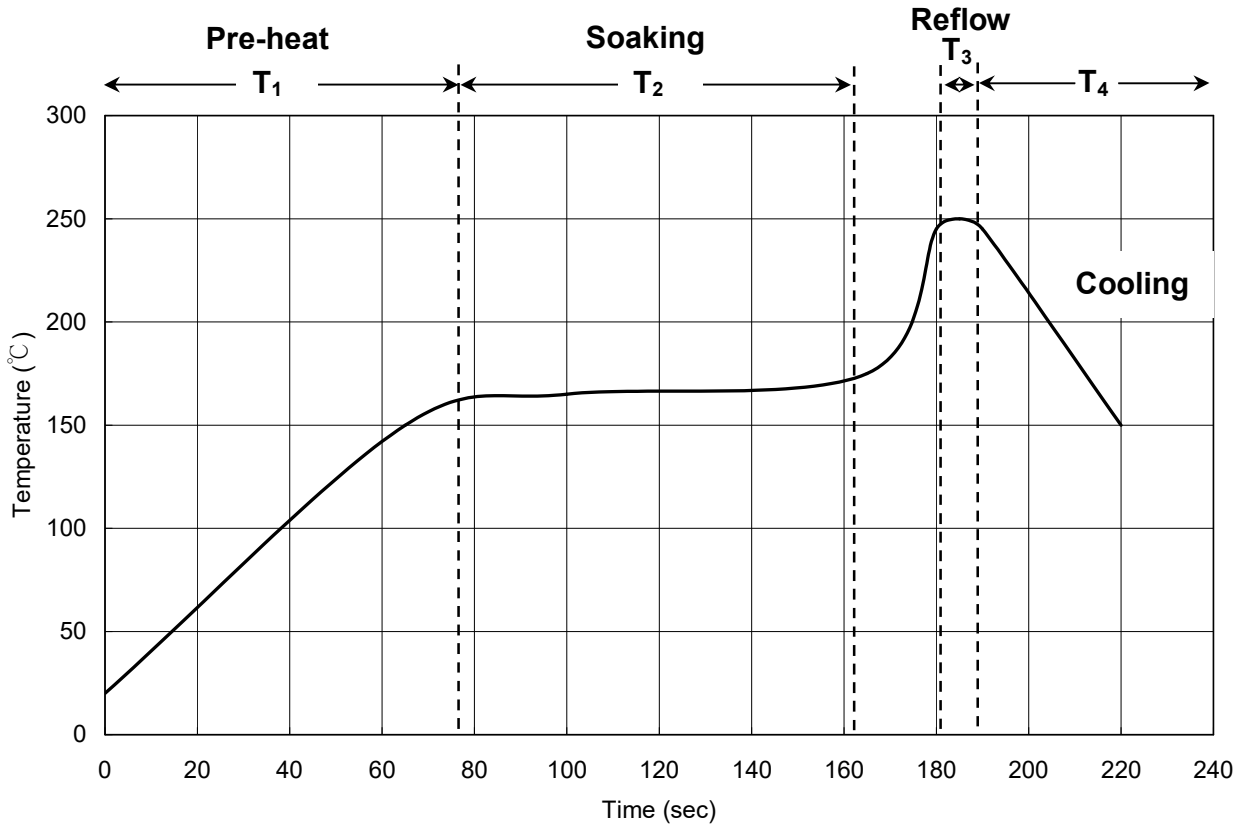

T ₁	Ramp up rate	1.0 ~ 3.0 °C /sec
	Pre-heat time	50 ~ 80 sec
T ₂	Soaking temperature	155 ~ 185 °C
	Dwell time during soaking	60 ~ 120 sec
T ₃	Reflow temperature	240 ~ 250 °C
	Reflow time	Max 10 sec
	Ramp up rate during reflow	1.2 ~ 2.3 °C /sec
T ₄	Cooling	1.0 ~ 6.0 °C /sec

Note: Suggest using Sn96Ag3Cu0.5 lead free solder.

Cleaning

Use alcohol-based cleaning solvents such as isopropyl alcohol to clean the LED if necessary.

This page is intended left blank.

For the latest product information, call us or visit: www.hplighting.com.tw

©2015, High Power Lighting Corporation(HPL), all rights reserved. This document contains information that is proprietary to HPL and may be duplicated in whole or in part by the original recipient for the internal business purposes only, provided that this entire notice appears in all copies. In accepting this document, the recipient agrees to make every reasonable effort to prevent unauthorized use of this information.

5F, No 173-8, Yung-Fon Road, Tu-Cheng District, New Taipei City, Taiwan, R.O.C.
TEL: +886-2-8262-8886 FAX : +886-2-8262-8885