

# Draft Specification For IR Series

## HPL-H39RL1ZA-ZN0



### Features

- Dimension : 3.9mm(L)×3.9mm(W)
- High Radiant Flux type
- All Metal Design Cu Substrate with Silicone Lens
- Narrow beam angle 60°
- Ultra low thermal resistance
- MSL Level : 3

### Applications

- Sensing System
- Medical appliances
- Surveillance
- Machine vision

**RoHS**  
Compliant

5F, No 173-8, Yung-Fon Road, Tu-Cheng District, New Taipei City, Taiwan, R.O.C.  
TEL: +886-2-8262-8886 FAX : +886-2-8262-8885



## Table of Contents

General Information .....	3
Part Number Matrix .....	4
Absolute Maximum Ratings .....	5
Initial Electrical/Optical Characteristics .....	5
Bin Code List for Reference .....	6
Characteristic Diagram .....	8
Outline Dimension.....	10
<b>Pad Configuration</b> .....	10
Recommended Solder Pattern.....	11
Shipping Package Style .....	12
Qualification Reliability Testing .....	18
Recommended Solder Profile .....	19

General Information

# HPL - H39RL1ZA

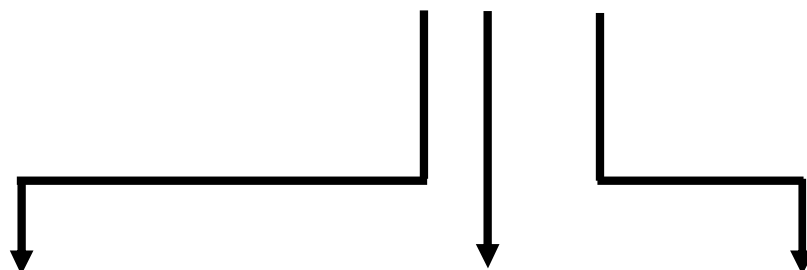

**Beam Angle-**  
Narrow beam angle

**Wavelength-**  
SWIR 1000-1600 nm

**Power-**  
0.5W

## Part Number Matrix

Wavelength \ Type	60° Lens	60° Lens & Star
SWIR 1000~1600	HPL-H39RL1ZA	HPL-H39TL1ZA



Do not poke the Led Lens with sharp object



Do not stack assembled PCB



Do not hold the Led with hand



Do not press or push the Led Lens

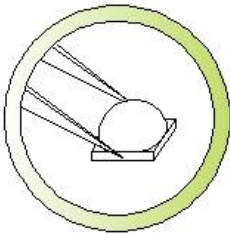

Hold the Led only by the substrate

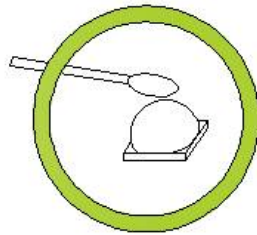

Clean the LED surface with cotton bud

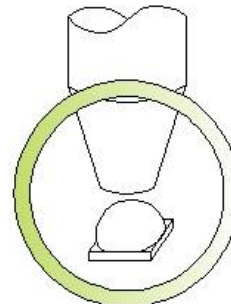

Use pick and place nozzle per recommendation in data sheet

## Absolute Maximum Ratings

(T<sub>j</sub>=25°C)

Parameter	Symbol	Rating	Unit
Power Dissipation	P	0.5	W
Forward Current	I <sub>F</sub>	350	mA
Reverse Voltage	V <sub>R</sub>	1	V
LED Junction Temperature	T <sub>J</sub>	115	°C
Operating Temperature Range	T <sub>opr</sub>	- 40°C to + 85°C	
Storage Temperature Range	T <sub>stg</sub>	- 40°C to + 120°C	
Soldering Condition	T <sub>sol</sub>	260°C For 10 Seconds	

## Initial Electrical/Optical Characteristics

(T<sub>j</sub>=25°C)

Parameter	Symbol	Min	Typ	Max	Test Condition	Unit
Peak wavelength	λ <sub>p</sub>	1300	-	1600	I <sub>F</sub> = 350mA	nm
Radiant Flux	Φ <sub>e</sub>	-	53.1	-		mW
Radiant Intensity	I <sub>e</sub>	-	41.4	-		mW/Sr
Forward Voltage	V <sub>F</sub>	-	1.45	-		V
Spectra half-width	Δλ	-	95	-		nm
Beam Angle	2Θ <sub>1/2</sub>	-	60	-		deg
Thermal Resistance, Junction-Case	R <sub>th, J-C1</sub>	-	5	-	-	°C/W

Note: 1. The thermal resistance value is measured with MCPCB (Star).

## Bin Code List for Reference

(Tj=25°C)

Item	Bin Code	Symbol	Condition	Min.	Max.	Unit
Forward Voltage <sup>1</sup>	9	V <sub>F</sub>	I <sub>F</sub> = 350 [mA]	1.11	1.35	V
	A			1.35	1.59	
	B			1.59	1.83	
Radiant Flux <sup>2</sup>	3	Φ <sub>e</sub>	I <sub>F</sub> = 350 [mA]	30	40	mW
	4			40	50	
	5			50	60	
	6			60	70	
Wavelength <sup>3</sup>	L3	λ <sub>p</sub>	I <sub>F</sub> = 350 [mA]	1300	1400	nm
	L4			1400	1500	
	L5			1500	1600	

Note

1. Forward voltage measurement allowance is ± 0.1V.
2. Radiant flux measurement allowance is ± 10%.
3. Wavelength measurement allowance is ± 2nm.

## Part Number Formation

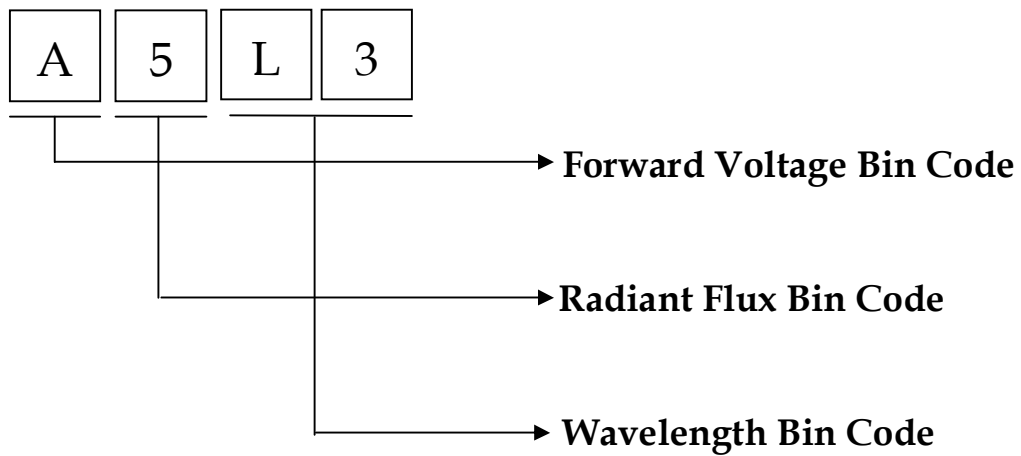
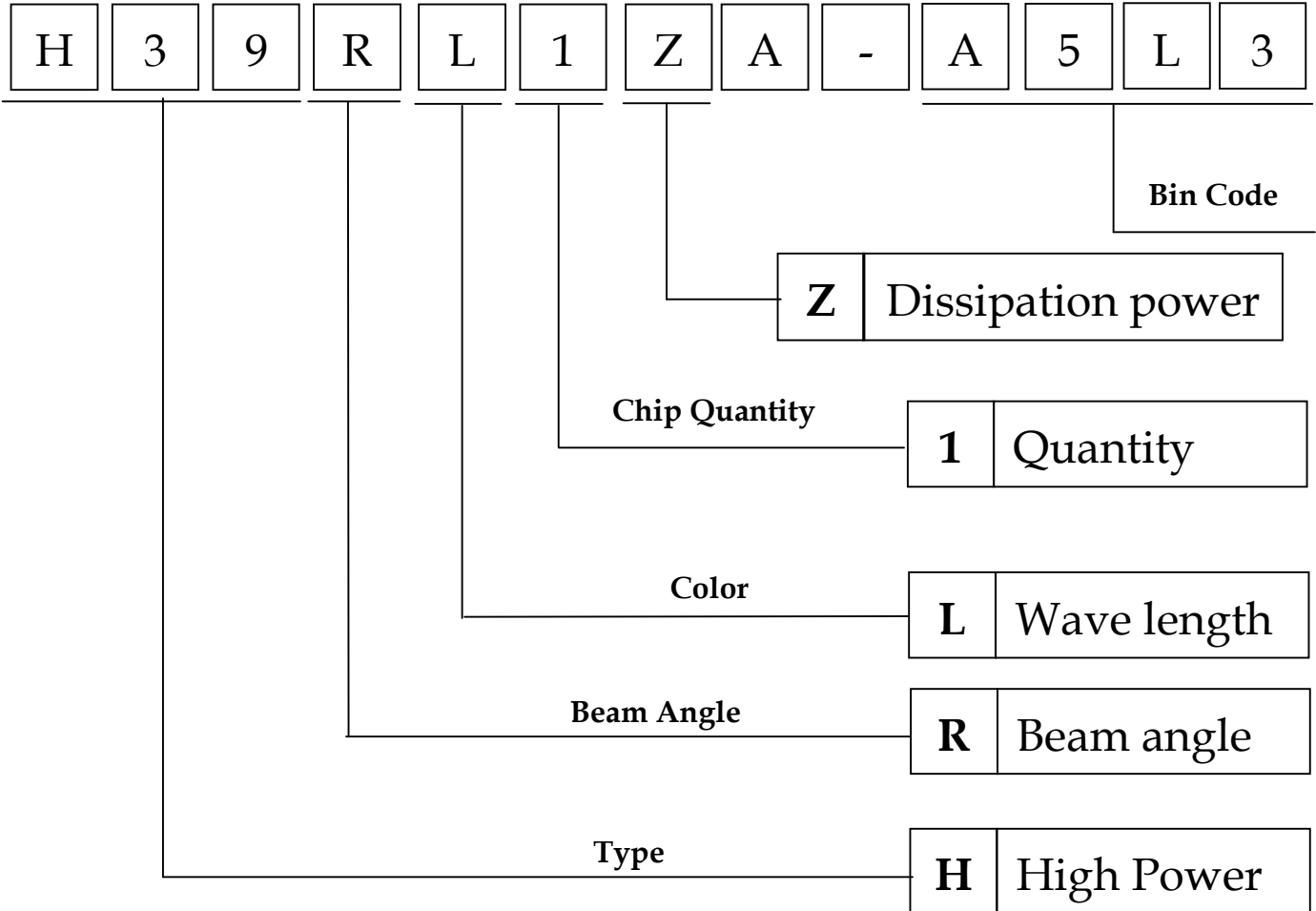

## Characteristic Diagram

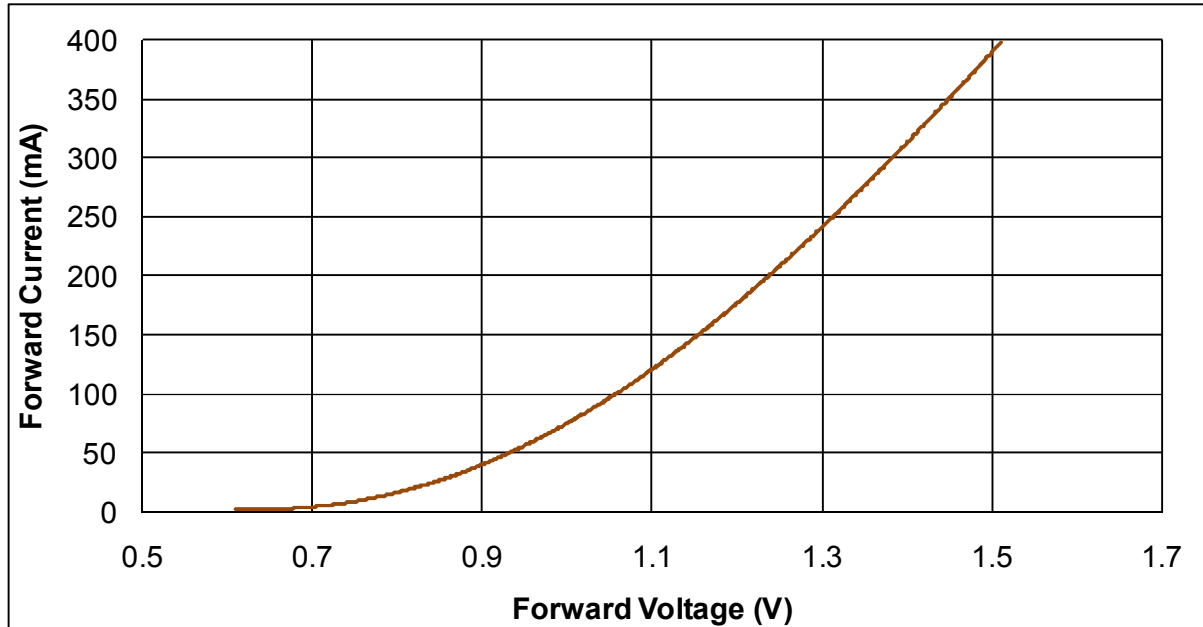

Fig. Forward Current vs. Forward Voltage

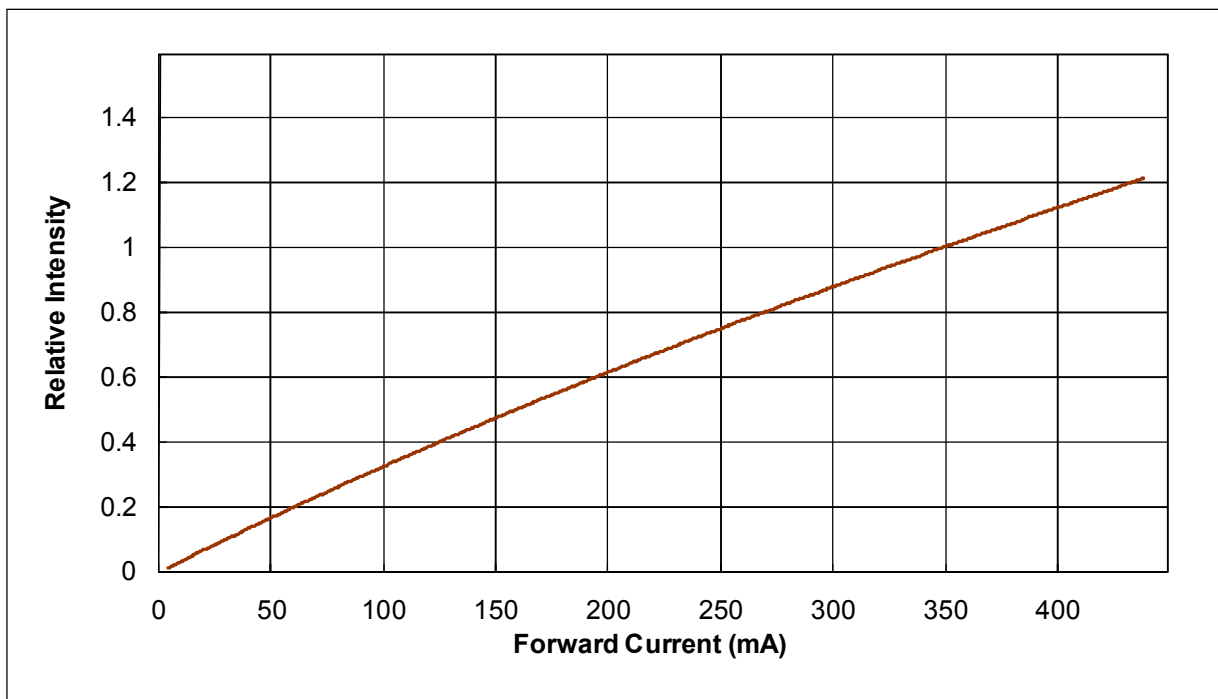

Fig. Relative Intensity vs. Forward Current



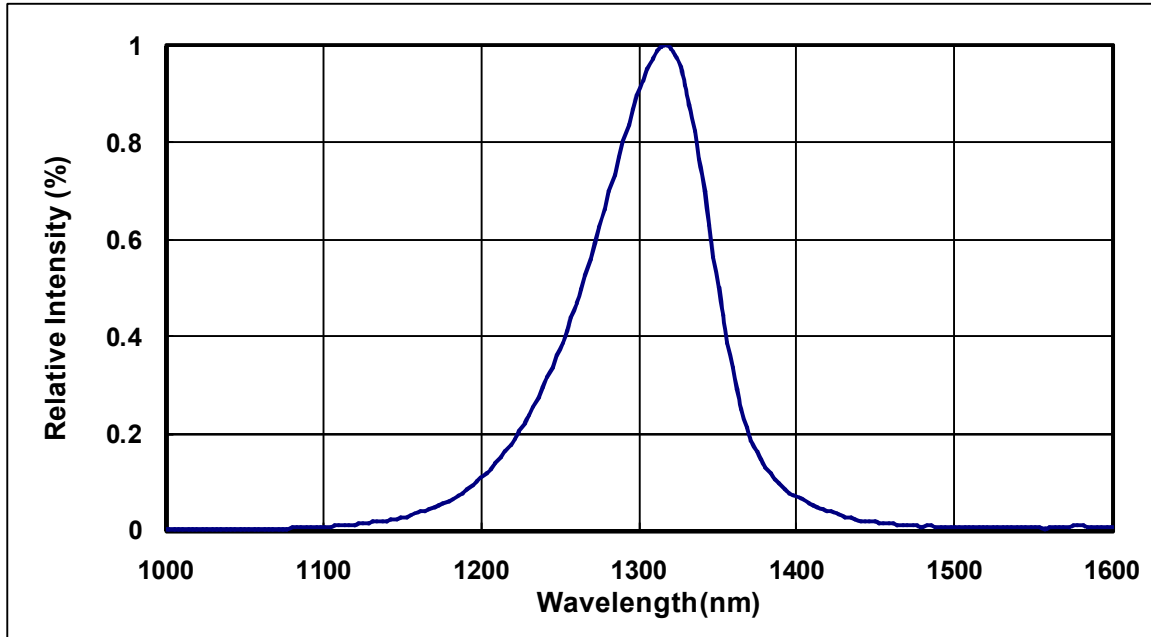

Fig. Typical Relative Intensity vs. wavelength

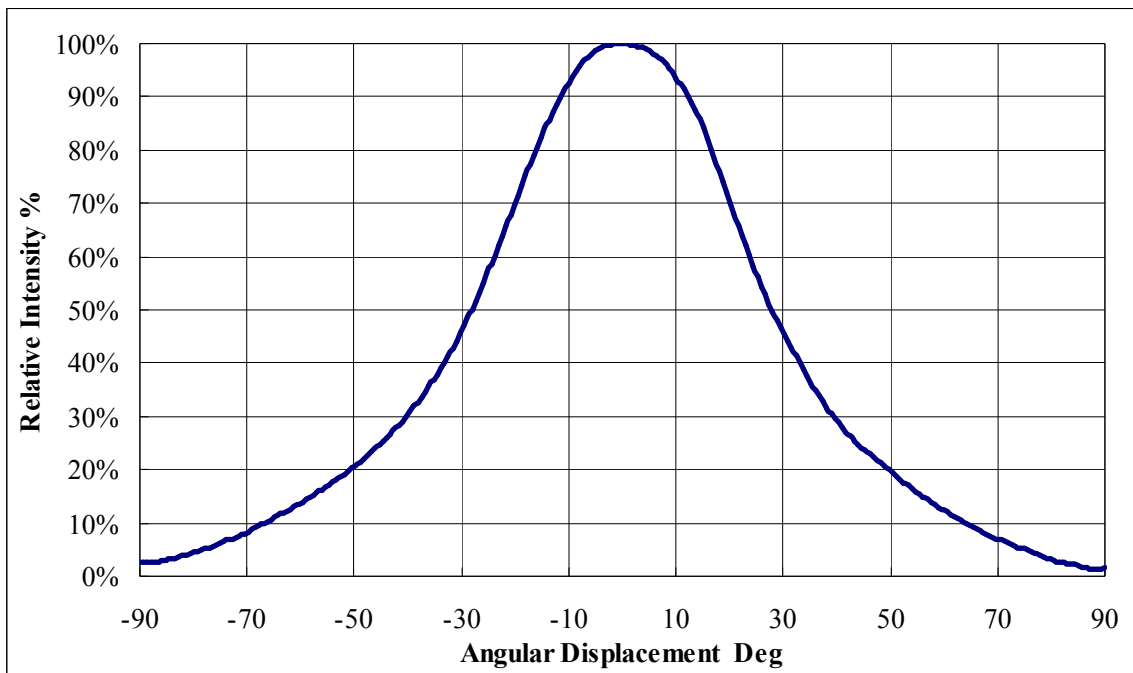

Fig. Typical Representative Spatial Radiation Pattern

## Outline Dimension

Unit : mm

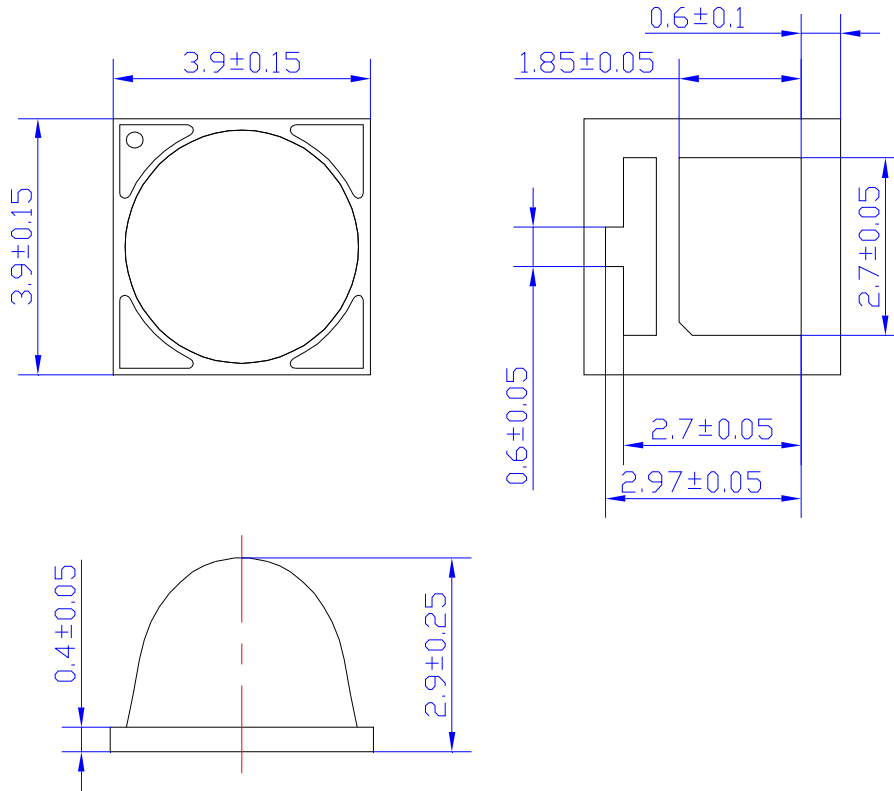
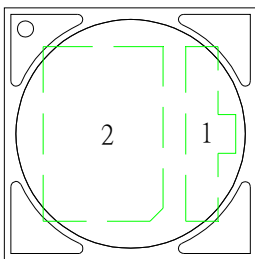
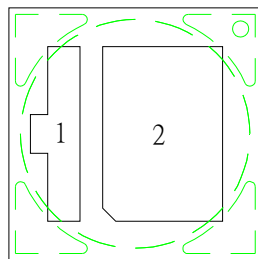

Fig. Package Outline Drawing.

### ● Pad Configuration



TOP



BOTTOM

PAD	Function
1	Anode
2	Cathode、Thermal

Fig. Pad configuration.

Note: Please don't put conductive material on the top surface of LEDs.

**Recommended Solder Pattern**

**Unit : mm**

**Tolerance±0.05**

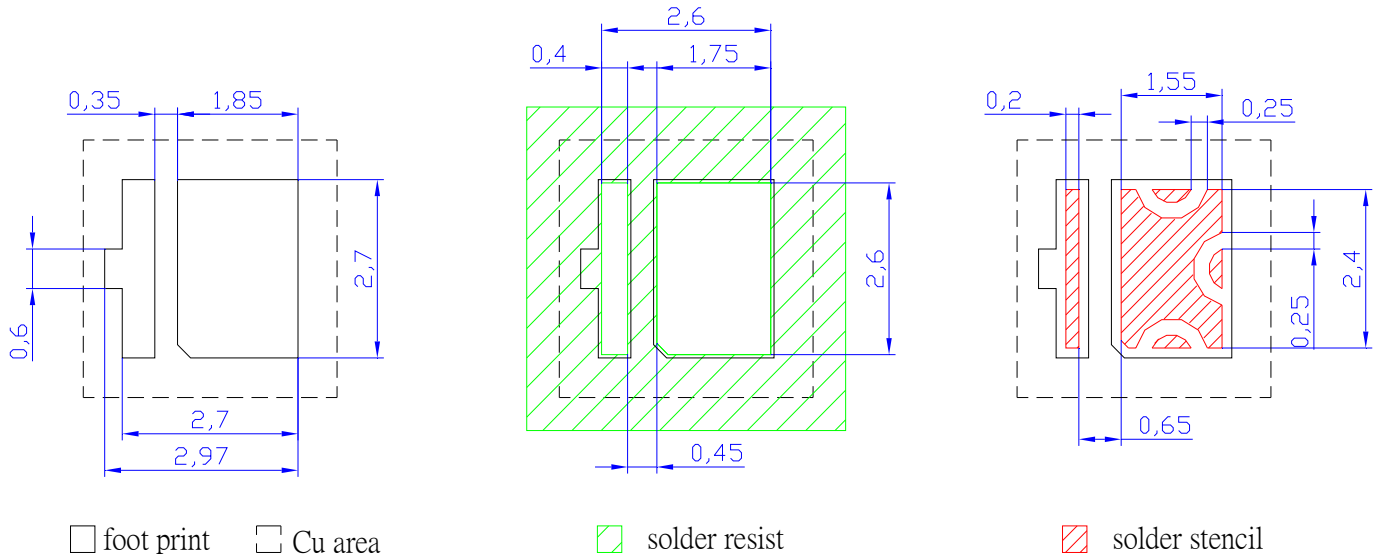

**Fig. Solder Pad Layout.**

## Shipping Package Style

### Tapping Dimension Packaging Specification

- Moisture proof bag.
- 1 Reel/bag.
- Q'ty : 2500(MAX)/Reel

Unit : mm

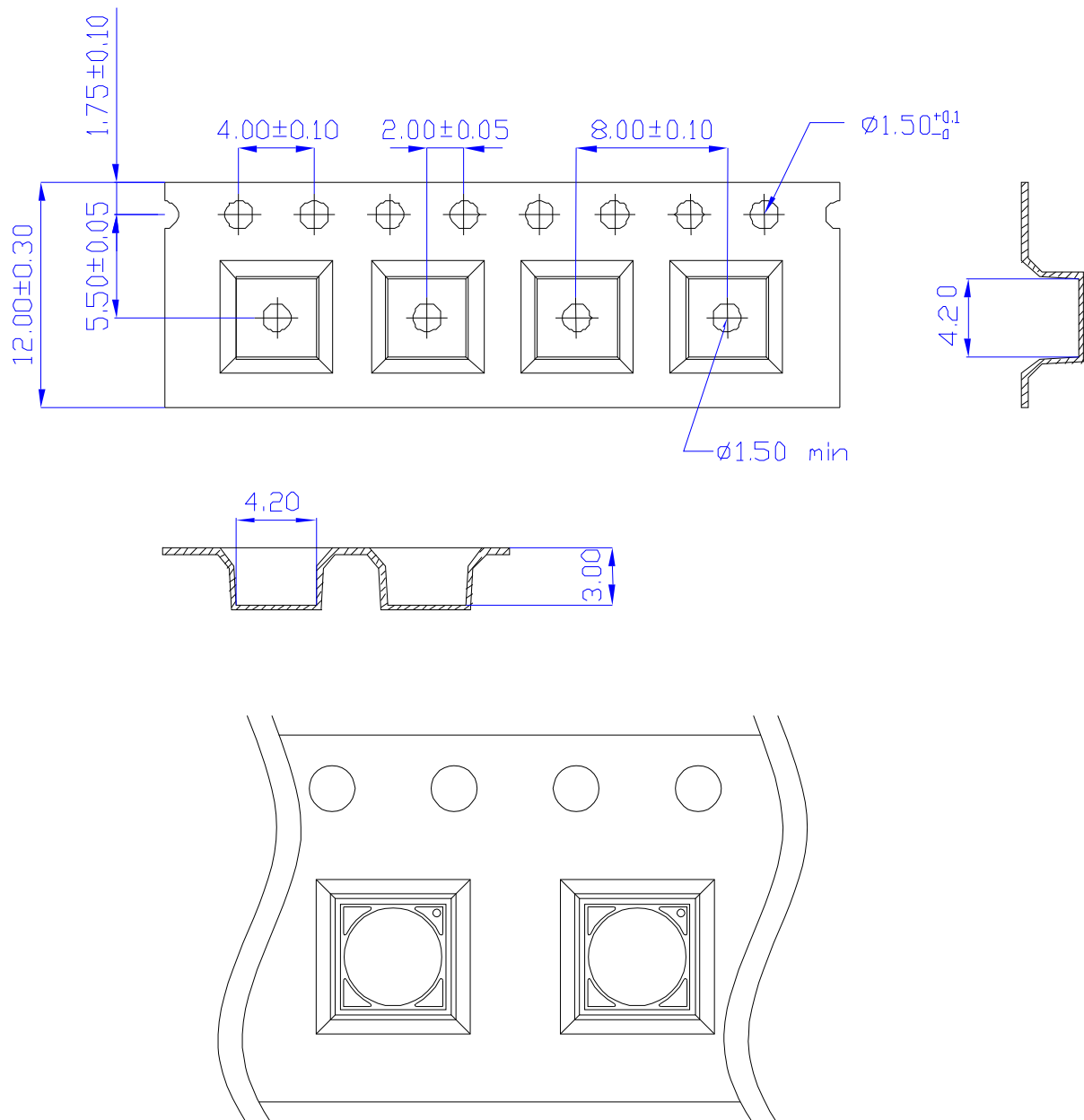

### 13 inch Reel Package

Box Type	Dimension (mm)	Reel/Box	Lens Type (Pcs)
Small Box(S)	415 x 380 x 95	5 Reel/Box	12500
Middle Box(M)	415 x 380 x 290	15 Reel/Box	37500
Large Box(L)	780 x 432 x 310	30 Reel/Box	75000

### Reel Packaging :

Reel Part :

Unit : mm

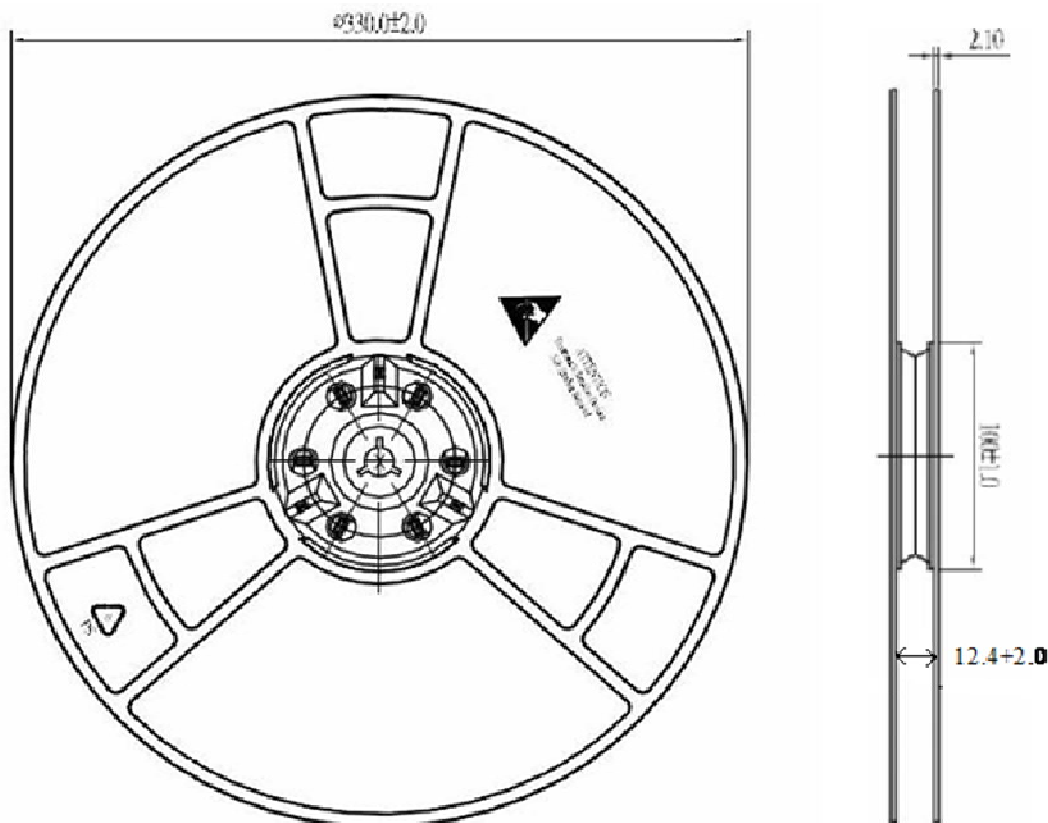

**Anti Statistic Bag :**

**Unit : mm**

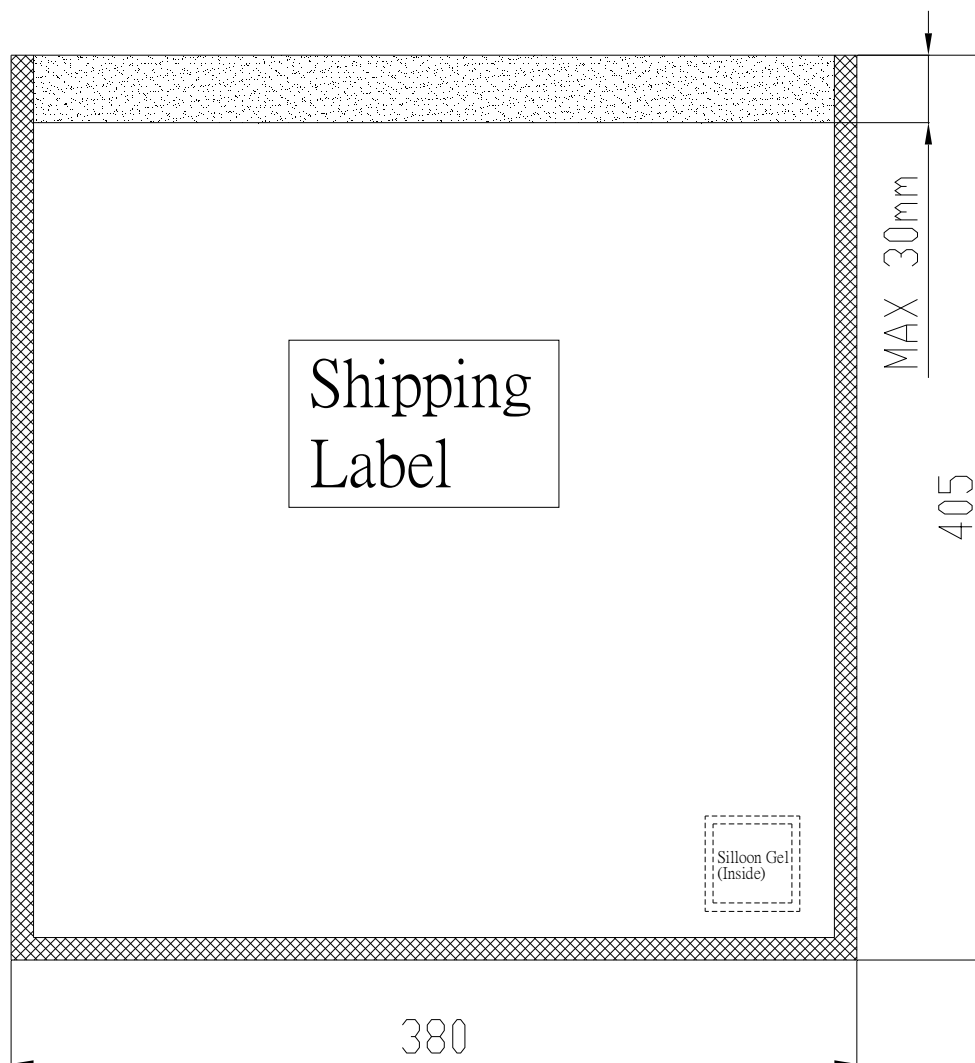

**Small Box**

Unit : mm

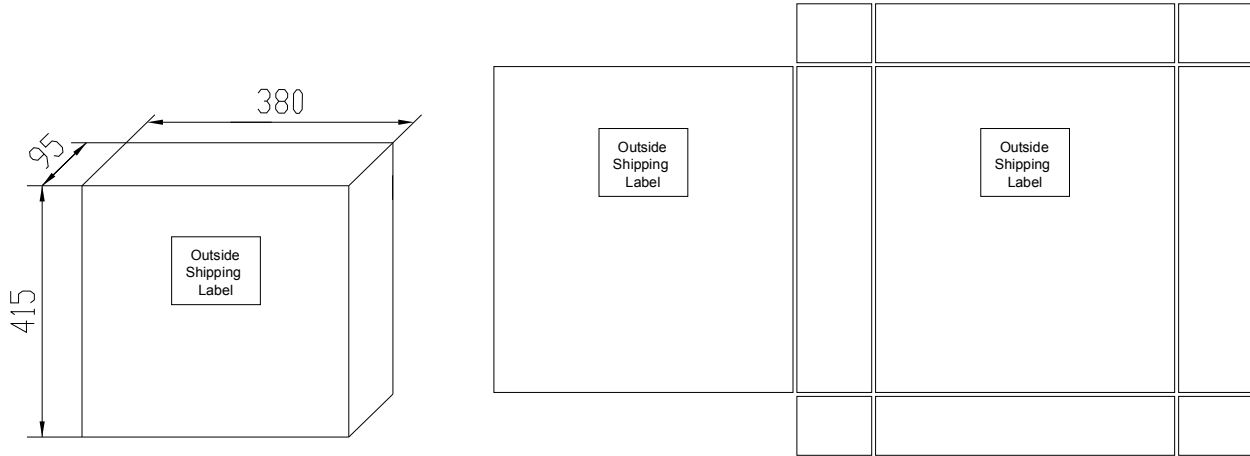

**Middle Box**

Unit : mm

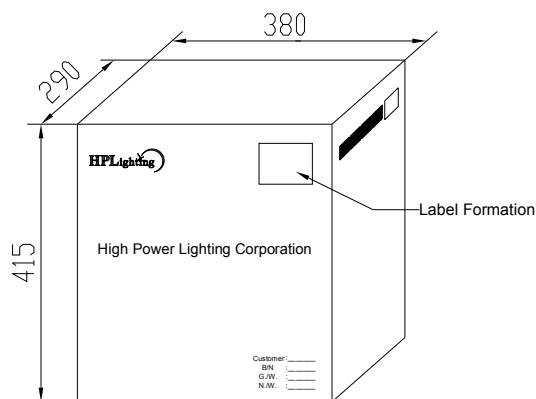
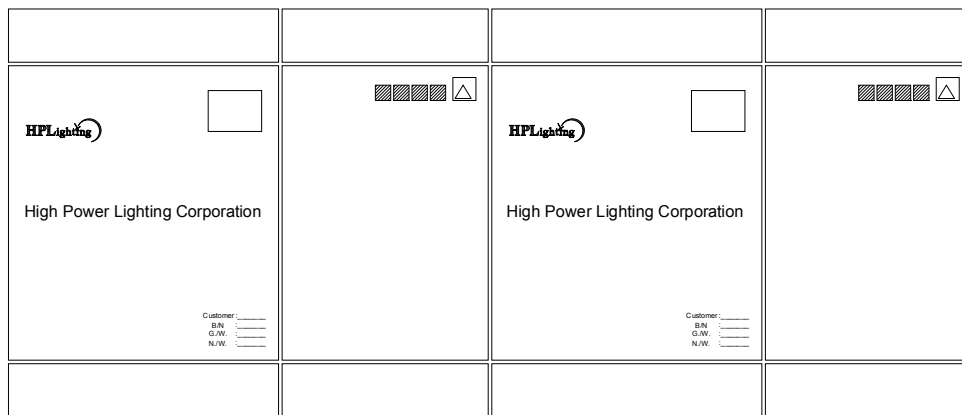

Large Box

Unit : mm

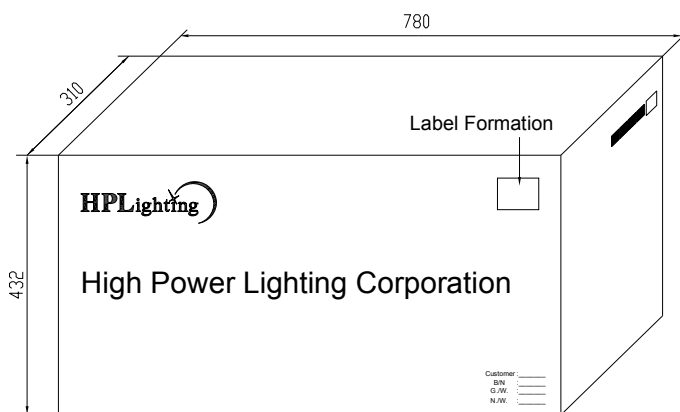
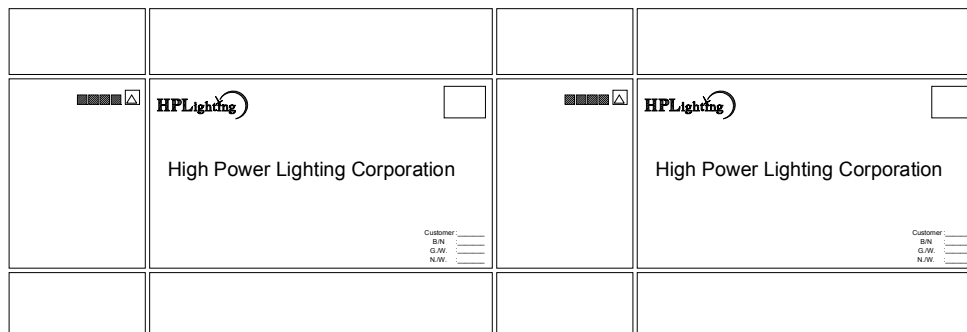



### Label Formation

70mm

	
P/N: XXXXXXXXXXXXXXXXX	BIN Rank: XXXXXXX
	
LOT: XXXXXXXXXXXXXXXXXXXX	Q'ty: XXXXX pcs
	
High Power Lighting Corporation (Taiwan)	XXX

40mm

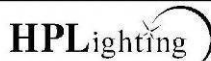
	
Customer :XXXXXXXXXXXXXXXXXXXXXX	
P/N: XXXXXXXXXXXXXXXXX	
OQC Stamp:	Q'ty: XXXXX pcs
High Power Lighting Corporation (Taiwan)	

## Qualification Reliability Testing

Classification	Test Item	Test conditions	Reference Standard
Endurance Test	Operation Life	$I_F = 350\text{mA}$ $T_a = 25^\circ\text{C}$ Test Duration = 1000hrs	MIL-STD-750: 1026 MIL-STD-883: 1005 JIS C 7021: B-1
	High Temperature High Humidity Storage	$T_a = 85\pm 5^\circ\text{C}$ RH = 85±5% Test Duration = 1000hrs	MIL-STD-202: 103B JIS C 7021: B-11
	High Temperature Storage	$T_a = 105\pm 5^\circ\text{C}$ Test Duration = 1000hrs	MIL-STD-202: 1008 JIS C 7021: B10
	Low Temperature Storage	$T_a = -40\pm 5^\circ\text{C}$ Test Duration = 1000hrs	JISC 7021: B-12
Environmental Test	Temperature Cycling	$-30^\circ\text{C} \sim 25^\circ\text{C} \sim 105^\circ\text{C} \sim 25^\circ\text{C}$ 30min 5min 30min 5min Test Duration = 10 cycle	MIL-STD-202: 107D MIL-STD-750: 1051 MIL-STD-883: 1010 JIS C 7021: A-4
	Thermal Shock	$-30\pm 5^\circ\text{C} \sim 105\pm 5^\circ\text{C}$ 30min 30min Test Duration = 10 cycle	MIL-STD-202: 107D MIL-STD-750: 1051 MIL-STD-883: 1011
	Solder Resistance	$T_{\text{sol}} = 260\pm 5^\circ\text{C}$ Dwell Time = 10sec	MIL-STD-202: 210A MIL-STD-750: 2031 JIS C 7021: A-1

Measuring Items	Symbol	Measuring Conditions	Failure Criteria
Forward voltage	$V_F$	$I_F = 350\text{mA}$	$V_F$ shift > 10%
Luminous	$I_v\%$	$I_F = 350\text{mA}$	$I_v\%$ shift > 10%

## Recommended Solder Profile

Soldering recommended soldering conditions:

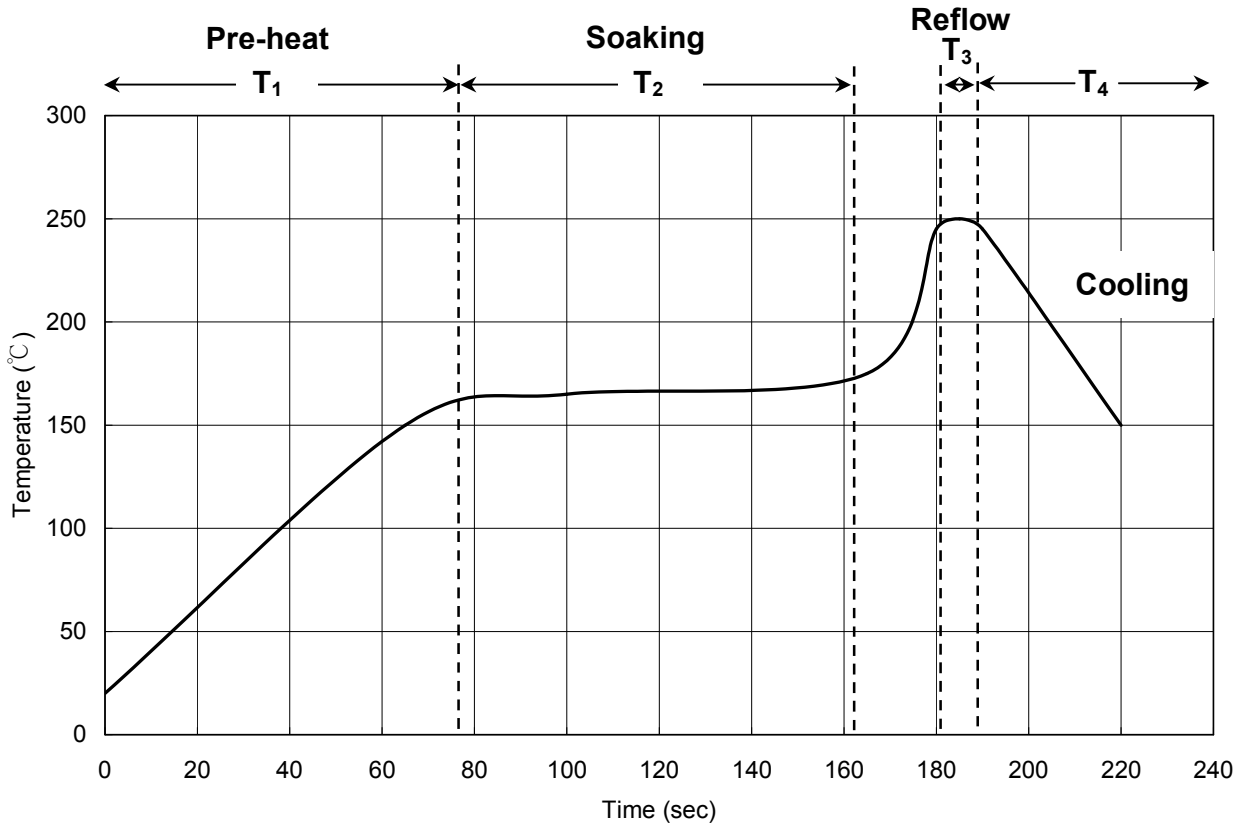

T <sub>1</sub>	Ramp up rate	1.0 ~ 3.0 °C/sec
	Pre-heat time	50 ~ 80 sec
T <sub>2</sub>	Soaking temperature	155 ~ 185 °C
	Dwell time during soaking	60 ~ 120 sec
T <sub>3</sub>	Reflow temperature	240 ~ 250 °C
	Reflow time	Max 10 sec
	Ramp up rate during reflow	1.2 ~ 2.3 °C/sec
T <sub>4</sub>	Cooling	1.0 ~ 6.0 °C/sec

Note: Suggest using Sn96Ag3Cu0.5 lead free solder.

### Cleaning

Use alcohol-based cleaning solvents such as isopropyl alcohol to clean the LED if necessary.



**This page is intended left blank.**

**For the latest product information, call us or visit: [www.hplighting.com.tw](http://www.hplighting.com.tw)**

©2022, High Power Lighting Corporation(HPL), all rights reserved. This document contains information that is proprietary to HPL and may be duplicated in whole or in part by the original recipient for the internal business purposes only, provided that this entire notice appears in all copies. In accepting this document, the recipient agrees to make every reasonable effort to prevent unauthorized use of this information.

5F, No 173-8, Yung-Fon Road, Tu-Cheng District, New Taipei City, Taiwan, R.O.C.  
TEL: +886-2-8262-8886 FAX : +886-2-8262-8885

**HPLighting Corp.**

[www.hplighting.com.tw](http://www.hplighting.com.tw)