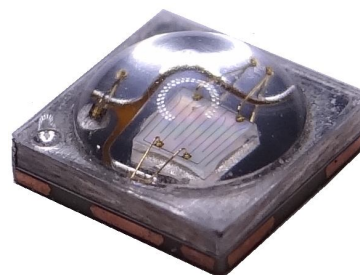


# Specification For UV Series

## HPL-H44LV1CQ



### Features

- High Efficacy 3W UV LED
- Dimension : 4.4mm(L)×4.4mm(W)
- All Metal Design Cu Substrate/Al reflector with Quartz Glass Lens
- View Angle 120°
- Low thermal resistance
- The InGaN Chip inside
- Superior ESD protection

### Applications

- UV Printing/UV Curing
- Medical
- Electronics Assembly
- Opto Electronics
- Special Lighting
- Defect Detection

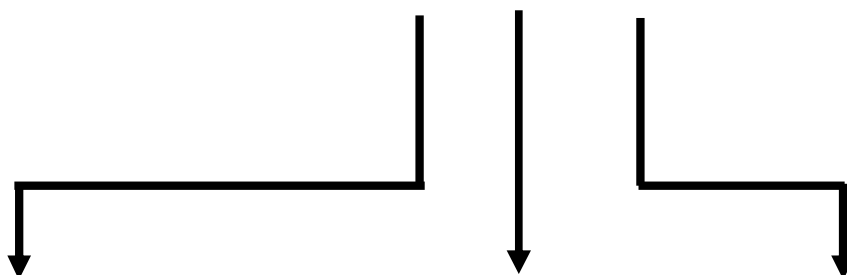
5F, No 173-8, Yung-Fon Road, Tu-Cheng District, New Taipei City, Taiwan, R.O.C.  
TEL: +886-2-8262-8886 FAX : +886-2-8262-8885

## Table of Contents

General Information .....	3
Part Number Matrix .....	4
Absolute Maximum Ratings .....	4
Initial Electrical/Optical Characteristics .....	5
Forward Voltage .....	5
Radiant Flux .....	5
Peak Wavelength .....	5
Spectra half-width .....	5
Typical Radiation Pattern .....	6
Bin Code List for Reference .....	7
Wavelength Bins .....	7
Part Number Formation .....	8
Characteristic Diagram .....	9
Outline Dimension .....	12
Pad Configuration .....	12
Recommended Solder Pattern .....	14
Shipping Package Style .....	15
Lens Type .....	15
Tapping Dimension Packaging Specification .....	15
Assembly Type .....	20
Tapping Dimension Packaging Specification .....	20
Qualification Reliability Testing .....	23
Recommended Solder Profile .....	24

General Information

**HPL - H44**X<sub>1</sub>X<sub>2</sub>1**CQ**



**X<sub>1</sub>:Lens & Assembly Type-**  
L : 120° Lens Emitter only  
F : 120° Lens Emitter on Standard Star

**X<sub>2</sub>:Color-**  
V: UV365~390nm

**Power-**  
C: 3W

## Part Number Matrix

Type Wavelength	120°Lens	120°Lens & Star
V	HPL-H44LV1CQ	HPL-H44FV1CQ

## Absolute Maximum Ratings

(T<sub>j</sub>=25°C)

Parameter	Symbol	Rating	Unit	
Power Dissipation	UV365-390nm	P	3	W
Forward Current	I <sub>F</sub>	700	mA	
Forward Pulse Current (1/10 Duty Cycle, 400msec Pulse Width)	I <sub>FP</sub>	1000	mA	
Thermal Resistance, Junction-Case	R <sub>th, J-C1</sub>	5	°C/W	
LED Junction Temperature	UV380-390nm	T <sub>J</sub>	100	°C
	UV365-380nm	T <sub>J</sub>	80	°C
Operating Temperature Range	T <sub>opr</sub>	- 40°C to + 80°C		
Storage Temperature Range	T <sub>stg</sub>	- 40°C to + 120°C		
Soldering Condition	T <sub>sol</sub>	260°C For 5 Seconds		

Note: 1. The thermal resistance value is measured with MCPCB (Star).

2. Case temperature conditions : (A) 380-390nm : Max 80°C ; (B) 365-380nm : Max 60°C

## Initial Electrical/Optical Characteristics

- Forward Voltage** (T<sub>j</sub>=25°C)

Wavelength	Forward Voltage					
	Symbol	MIN.	TYP.	MAX.	Test Condition	Unit
365~390nm	V <sub>F</sub>	3.03	3.9	4.47	I <sub>F</sub> = 700mA	V

**Caution:** The real output is decided by chip capability

- Radiant Flux**(T<sub>j</sub>=25°C)

Wavelength	Radiant Flux					
	Symbol	MIN.	TYP.	MAX.	Test Condition	Unit
380~390nm	Φ <sub>e</sub>	700	1000	-	I <sub>F</sub> = 700mA	mW
365~380nm		450	650	-		

**Caution:** The real output is decided by chip capability

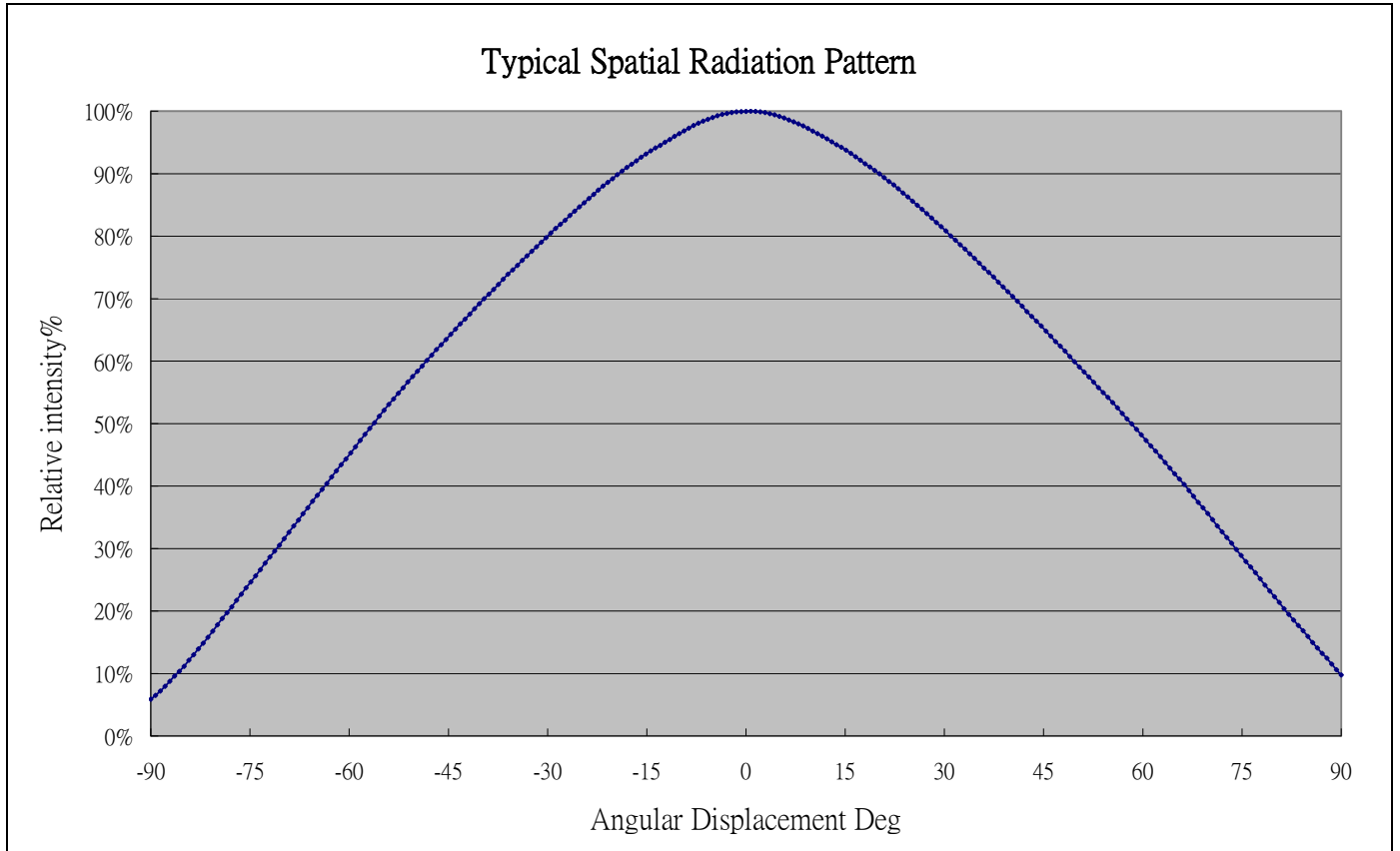
- Peak wavelength** (T<sub>j</sub>=25°C)

Wavelength	Wavelength					
	Symbol	MIN.	TYP.	MAX.	Test Condition	Unit
365~390nm	λ <sub>p</sub>	365	-	390	I <sub>F</sub> = 700mA	nm

- Spectra half-width** (T<sub>j</sub>=25°C)

Wavelength	Wavelength					
	Symbol	MIN.	TYP.	MAX.	Test Condition	Unit
365~390nm	Δλ	-	15	-	I <sub>F</sub> = 700mA	nm

● **Typical Radiation Pattern**



**Fig. (120° Lens) Typical Representative Spatial Radiation Pattern**

● Bin Code List for Reference

(T<sub>j</sub>=25°C)

Item	Bin Code	Symbol	Condition	Min.	Max.	Unit
Forward Voltage <sup>1</sup>	H	V <sub>F</sub>	I <sub>F</sub> = 700 [mA]	3.03	3.27	V
	J			3.27	3.51	
	K			3.51	3.75	
	L			3.75	3.99	
	M			3.99	4.23	
	N			4.23	4.47	
Radiant Flux <sup>2</sup>	C	Φ <sub>e</sub>	I <sub>F</sub> = 700 [mA]	275	350	mW
	D			350	425	
	E			425	500	
	F			500	600	
	G			600	700	
	H			700	800	
	J			800	900	

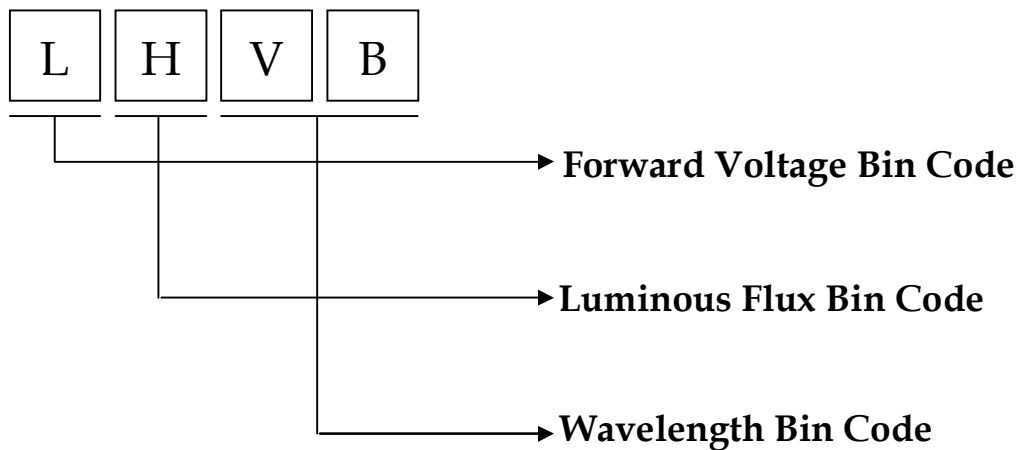
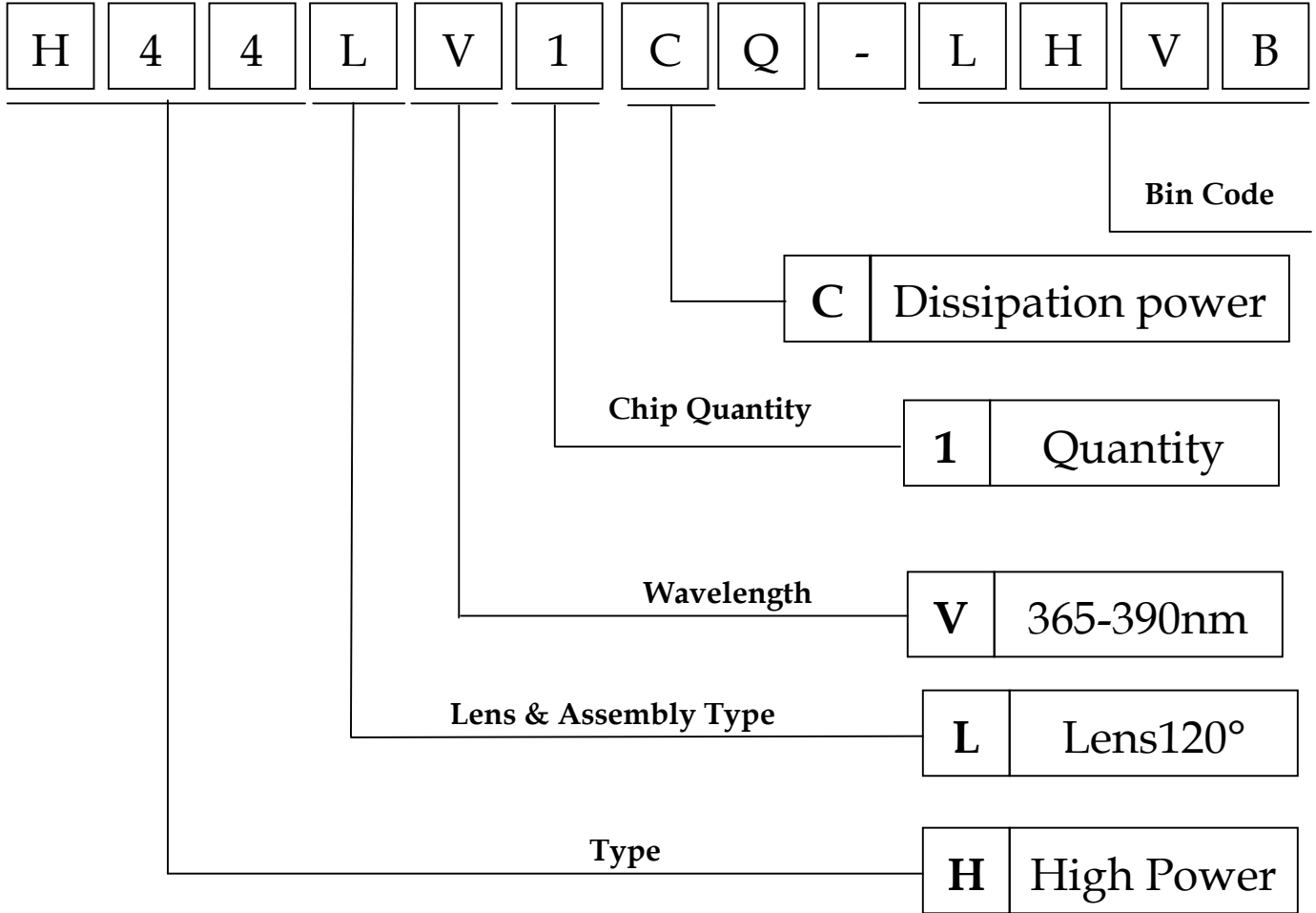
● Wavelength Bins

Wavelength <sup>3</sup>	Bin Code	Symbol	Condition	Min.	Max.	Unit
V 365~390nm	VC	λ <sub>p</sub>	I <sub>F</sub> = 700 [mA]	385	390	nm
	VB			380	385	
	VA			375	380	
	VZ			370	375	
	VY			365	370	

Note

1. Forward voltage measurement allowance is ± 0.1V.
2. Radiant flux measurement allowance is ± 10%.
3. Wavelength measurement allowance is ± 2nm.

## Part Number Formation





## Characteristic Diagram

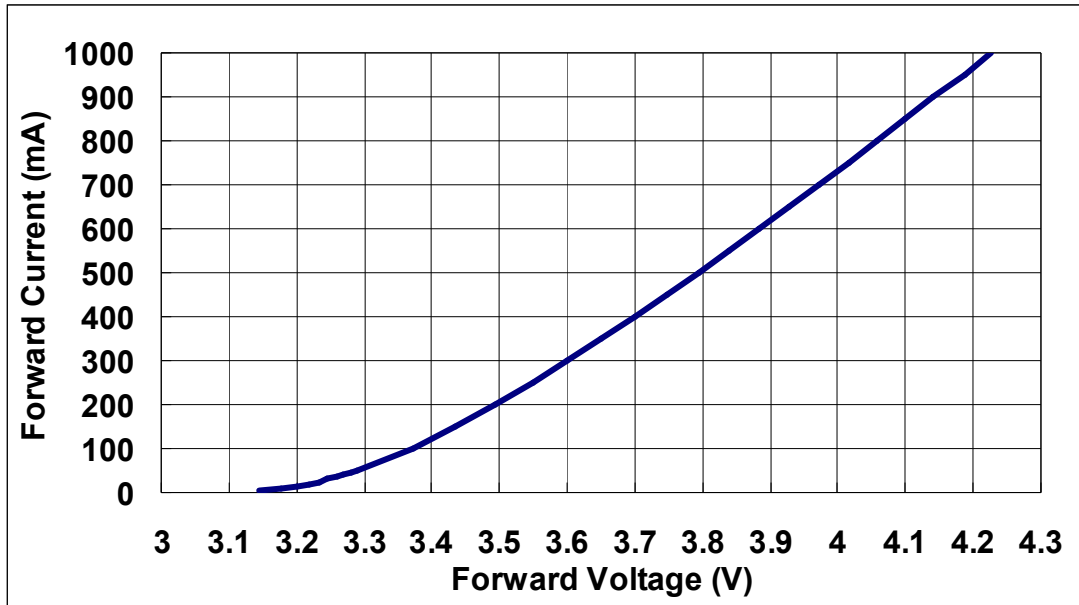


Fig. Forward Current vs. Forward Voltage

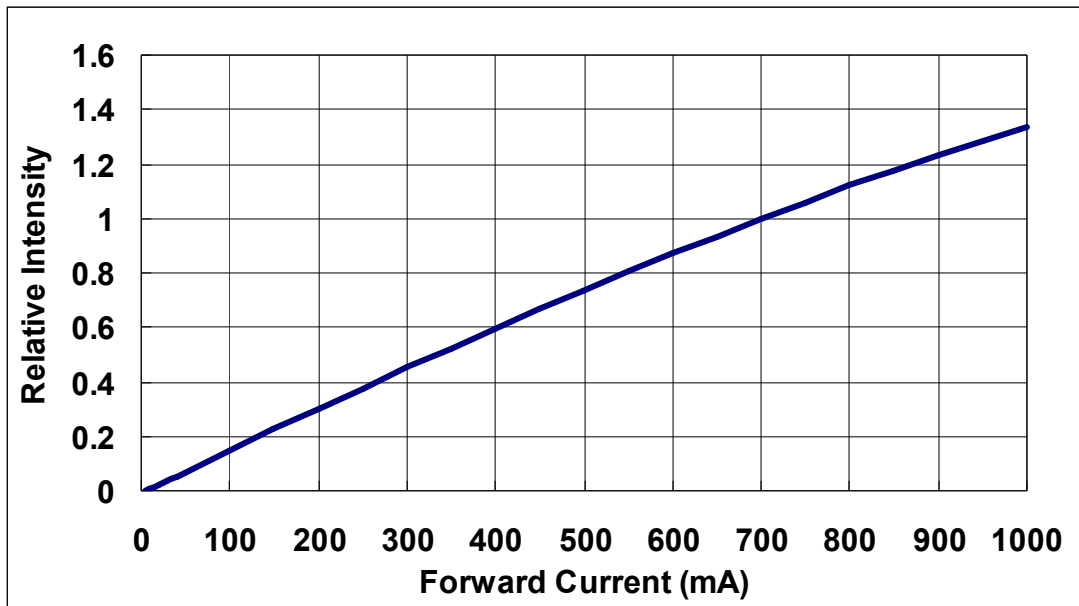


Fig. Relative Intensity vs. Forward Current.

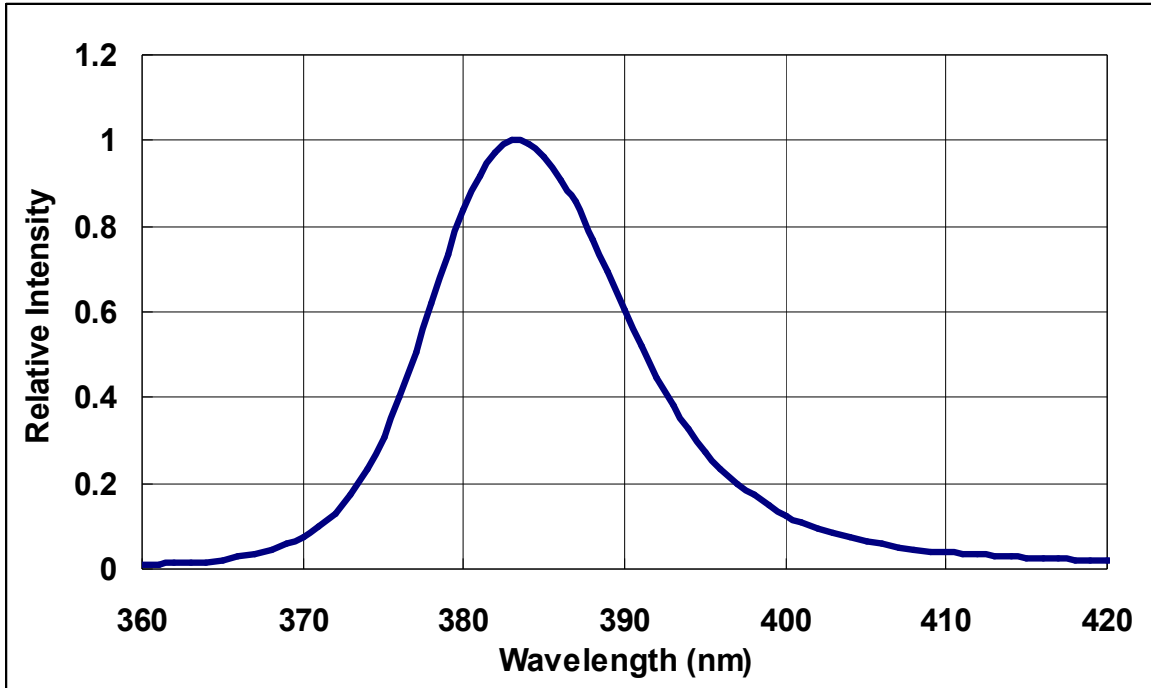


Fig. Typical Relative Intensity vs. wavelength

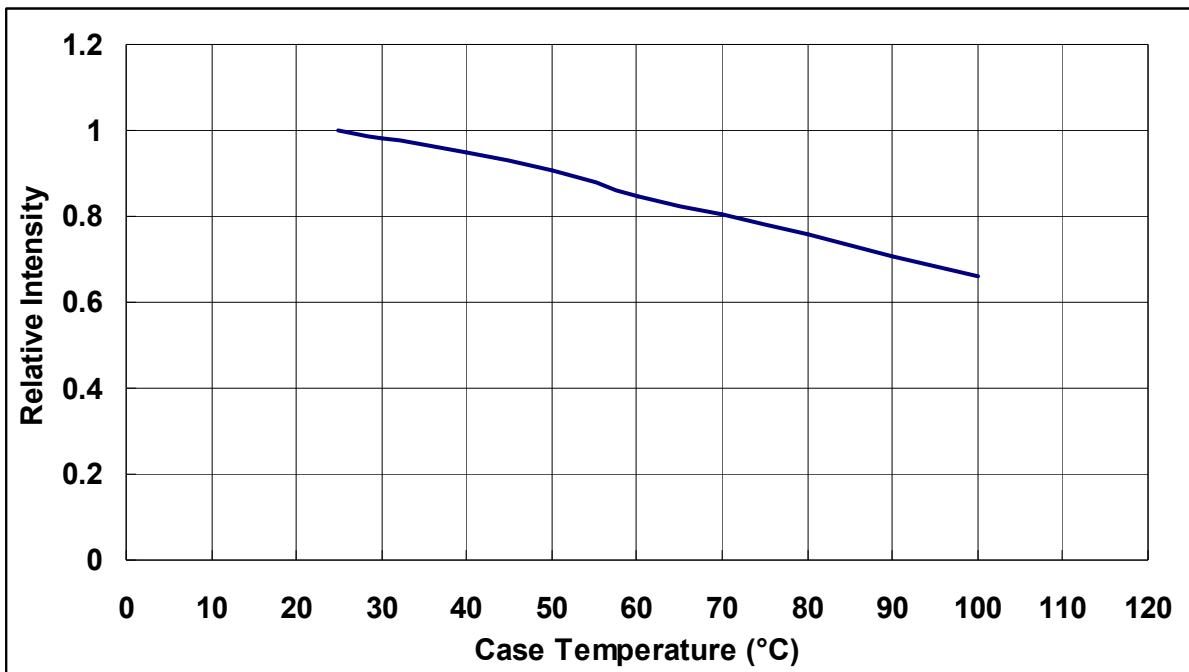


Fig. Relative Intensity vs. Case Temperature

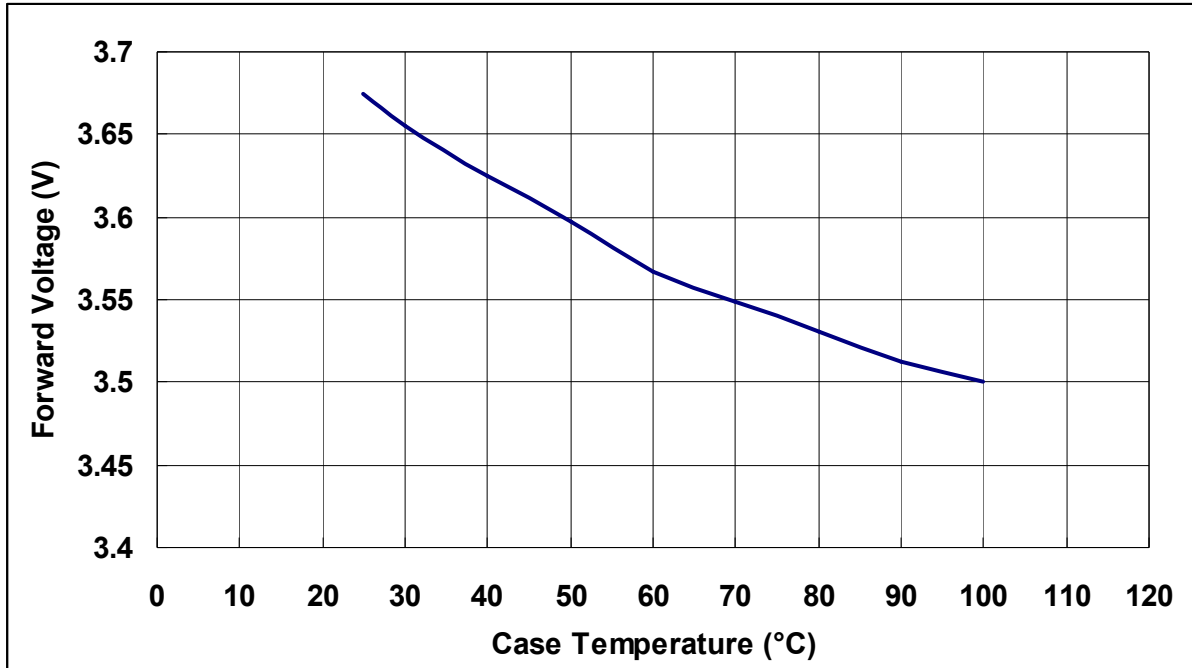


Fig. Forward Voltage vs. Case Temperature

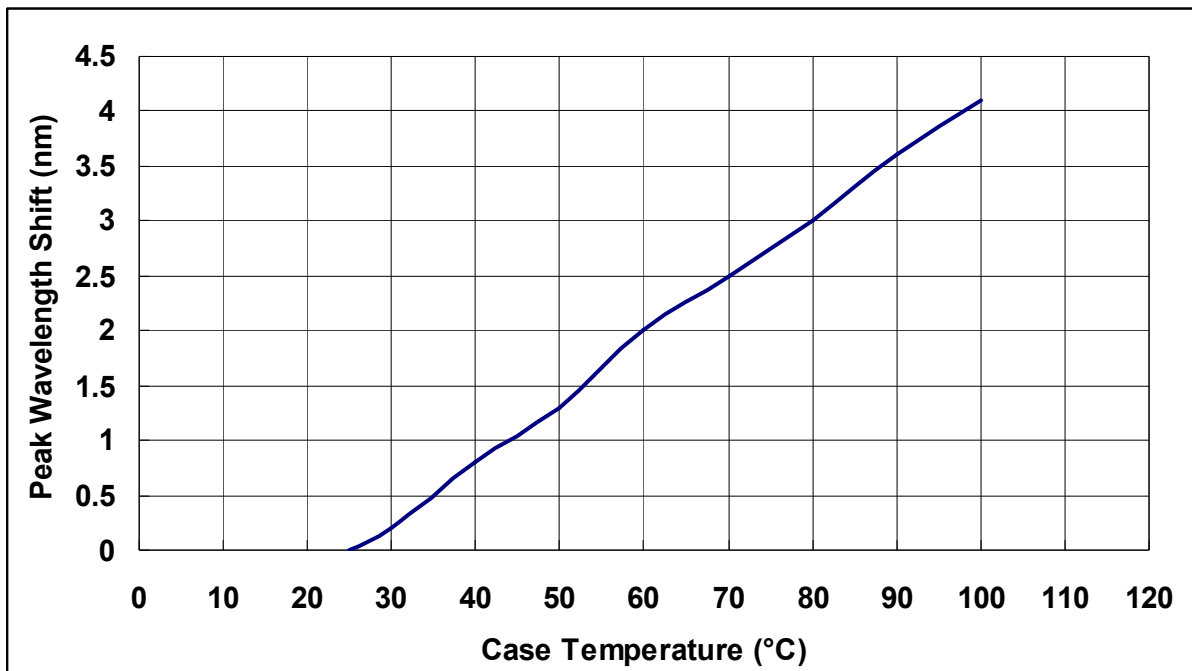


Fig. Peak Wavelength shift vs. Case Temperature

## Outline Dimension

### HPL-H44LV1CQ

Unit : mm

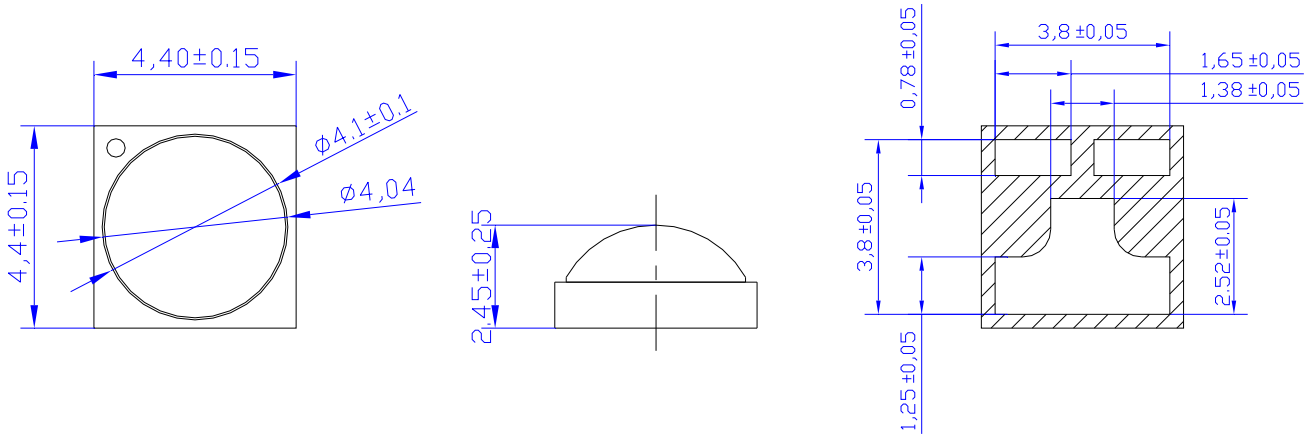
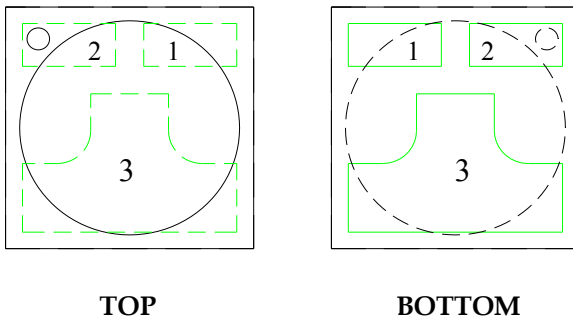


Fig. Package Outline Drawing.

## Pad Configuration

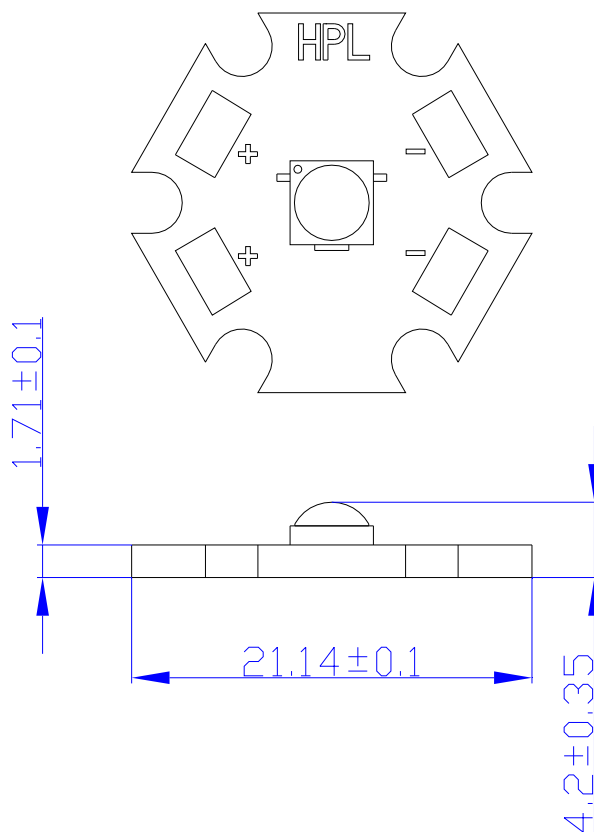


PAD	Function
1	Cathode
2	Anode
3	Thermal · Anode

Fig. Pad configuration.

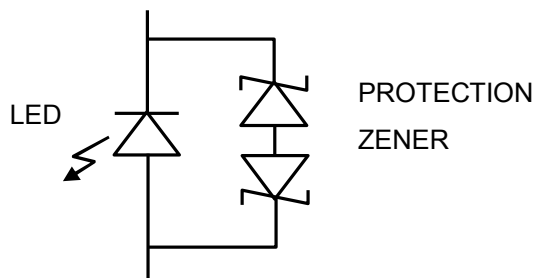
Note : Thermal pad is not electrically neutral. Do not electrically connect either the anode or cathode to the Thermal pad.

**HPL-H44FV1CQ**

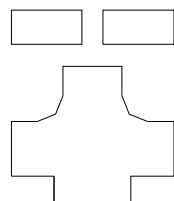
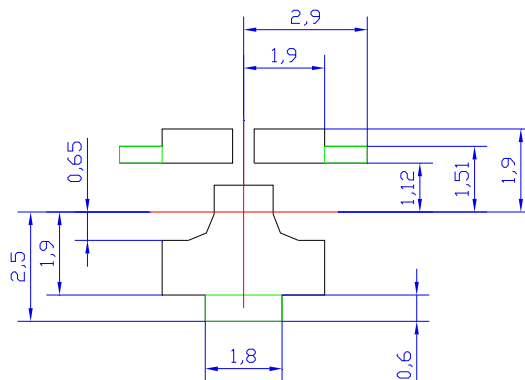


**Fig. Assembly r Outline Drawing.**

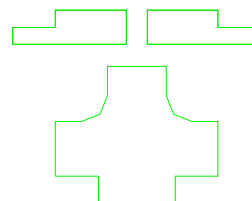
**PROTECTION CIRCUIT**



## Recommended Solder Pattern



SOLDER  
MASK



COPPER  
LAYOUT

Fig. Solder Pad Layout.

## Shipping Package Style

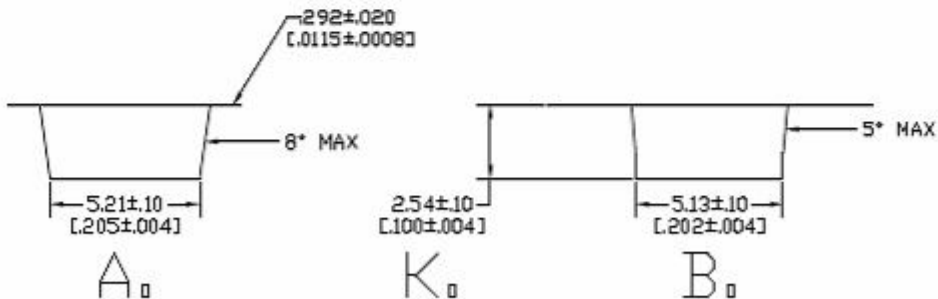
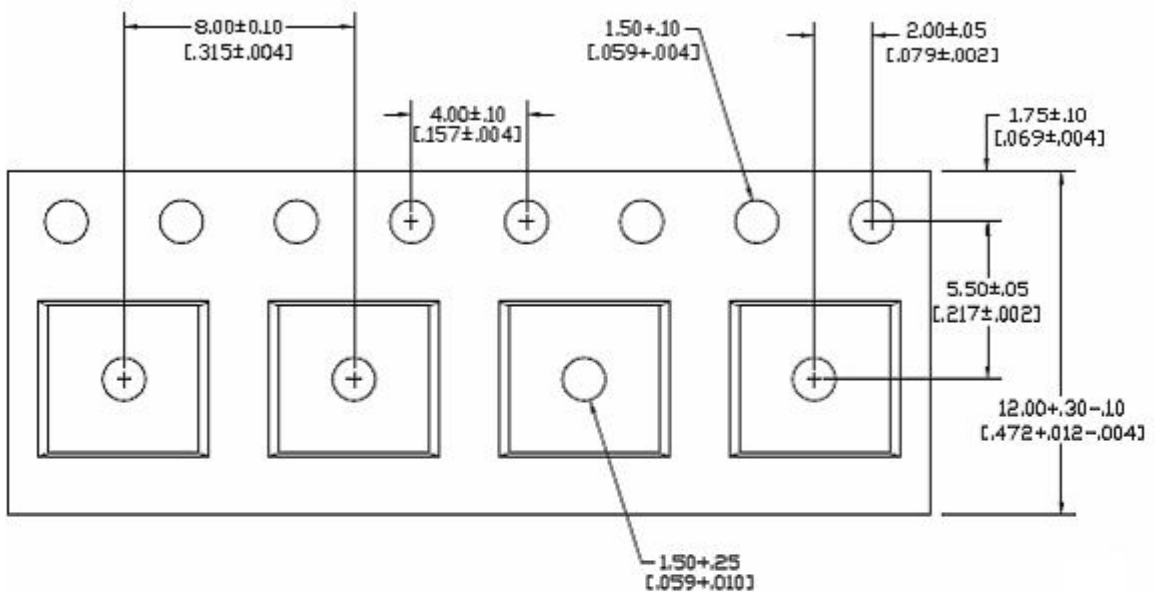
### Lens Type

#### Tapping Dimension Packaging Specification

##### 120 Degree Lens Type :

- Moisture proof bag.
- 1 Reel/bag.
- Q'ty: 800(MAX)/Reel.

Unit : mm



MM  
[INCH]

### Label Formation

P/N: XXXXXXXXXXXXXXX	BIN Rank : XXXXXXXXXXX
LOT: XXXXXXXXXXXXXXX	Q'ty : XXXX PCS XXX

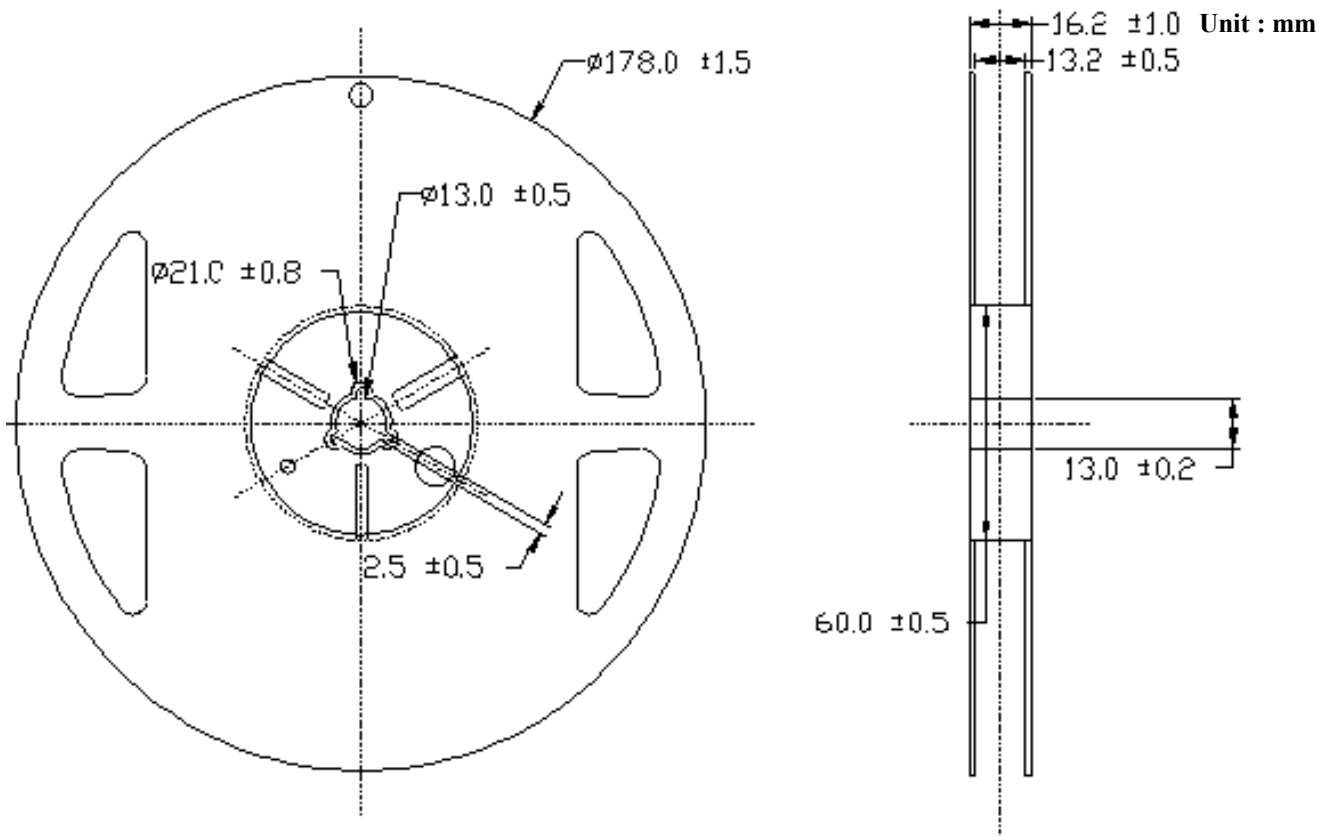
75mm\*8mm

### Package

Box Type	Dimension (mm)	Reel/Box	60°Lens Type (Pcs)	120°Lens Type(Pcs)
Small Box(S)	230x85x265	5 Reel/Box	3250	4000
Middle Box(M)	470x265x270	30 Reel/Box	19500	24000
Large Box(L)	470x435x270	50 Reel/Box	32500	40000

### Reel Packaging :

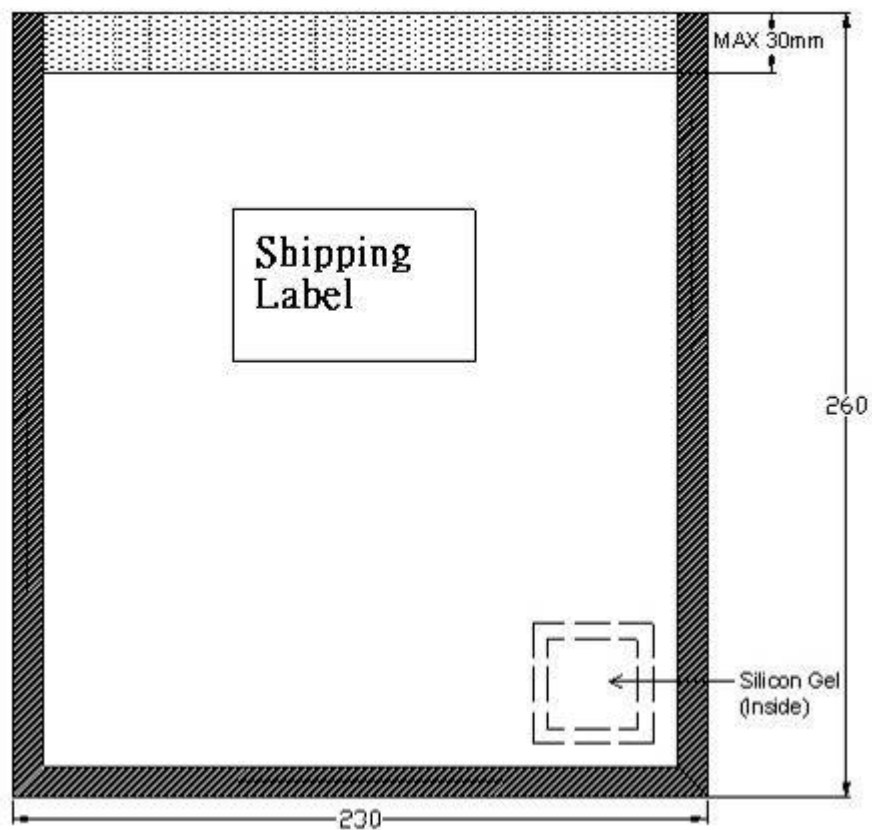
Reel Part :





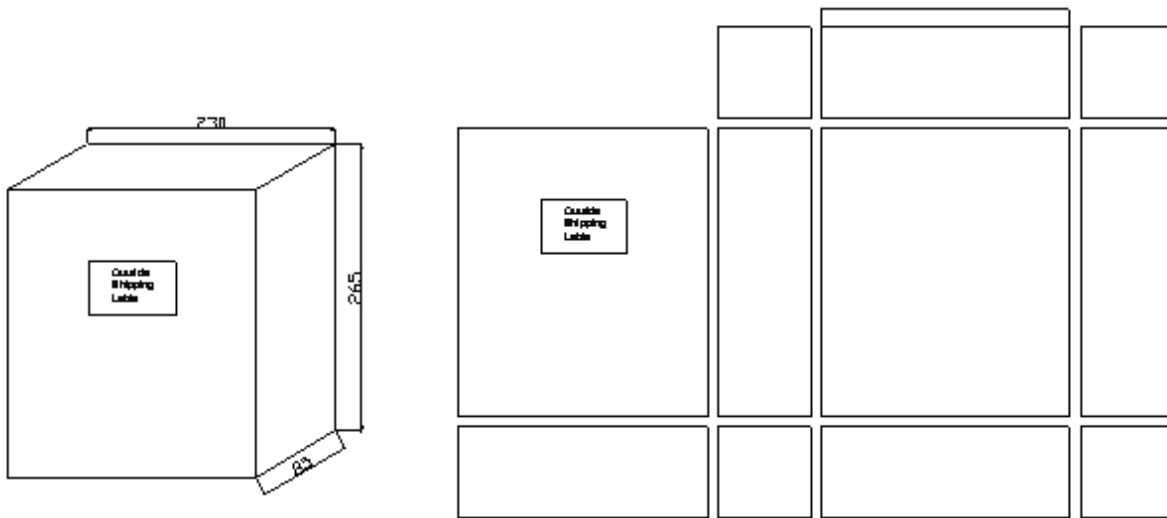
**Anti Statistic Bag :**

**Unit : mm**



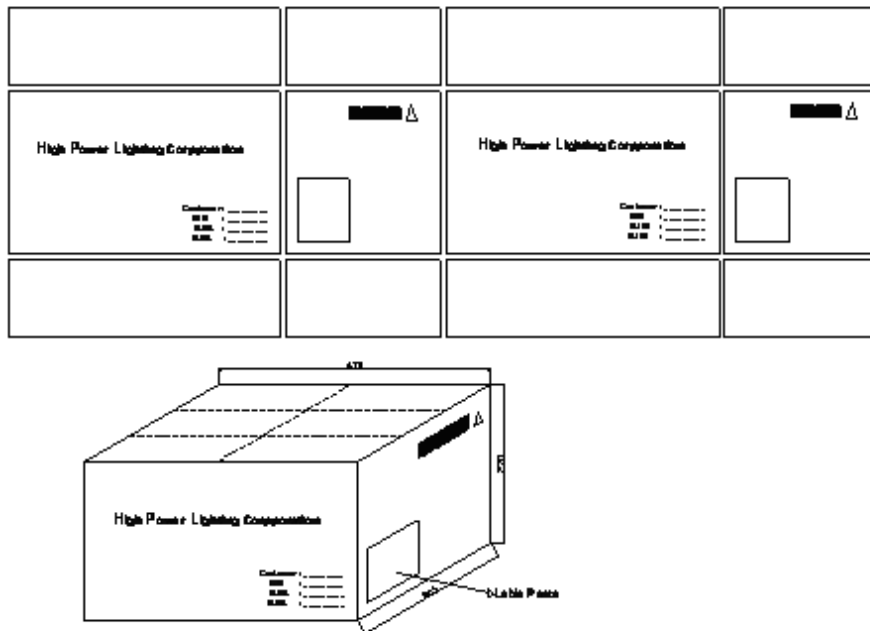
**Small Box**

Unit : mm



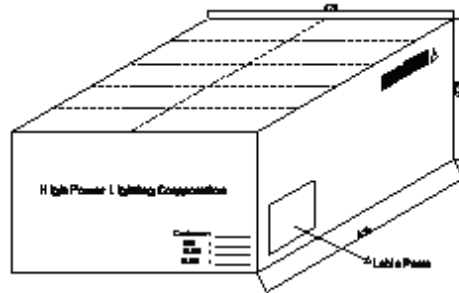
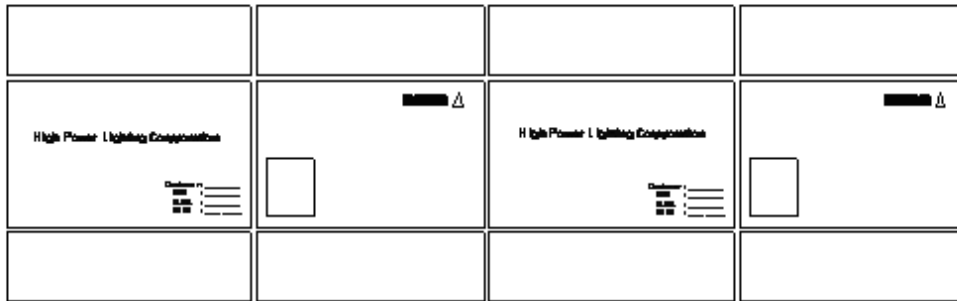
**Middle Box**

Unit : mm



Large Box

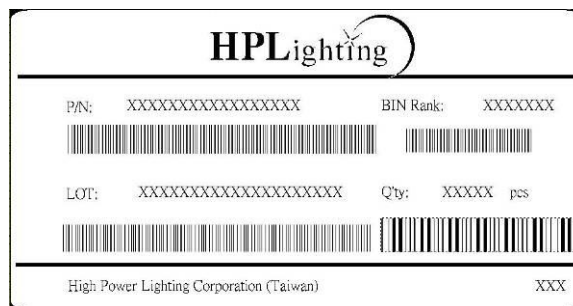
Unit : mm



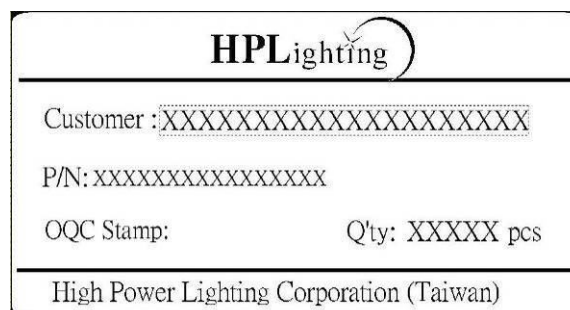
Label Formation

70mm

Unit : mm



40mm



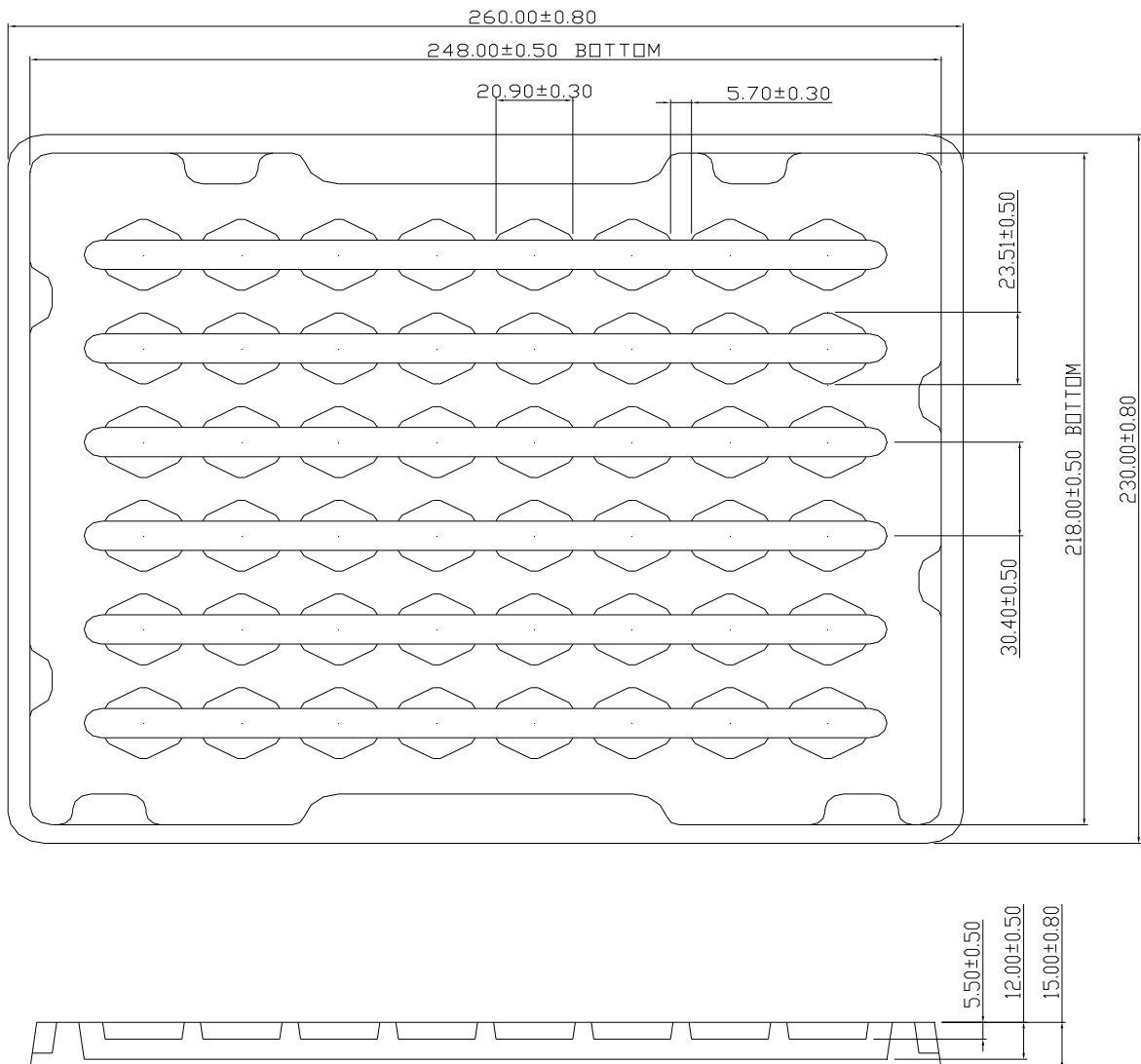
## Assembly Type

### Tapping Dimension Packaging Specification

#### 120 Degree Assembly Type :

- Moisture proof bag.
- 21 Tray (MAX) /bag.
- Q'ty: 48pcs(MAX)/Tray

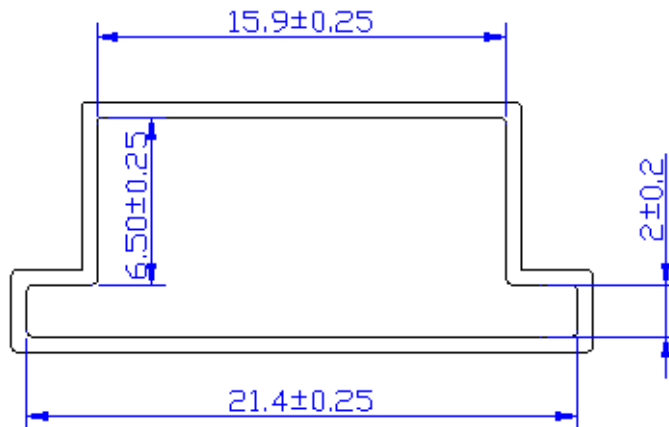
Unit : mm



### 120 Degree Assembly Type :

- 1 Tube
- Q'ty:20pcs(MAX)/Tube
- Q'ty: 300 Tube (MAX)/Box

Unit : mm



#### NOTES:

General tolerance=± 0.25mm  
Material :PVC,Clear  
THICKNESS : 0.60±0.1  
LENGTH : 424±2mm

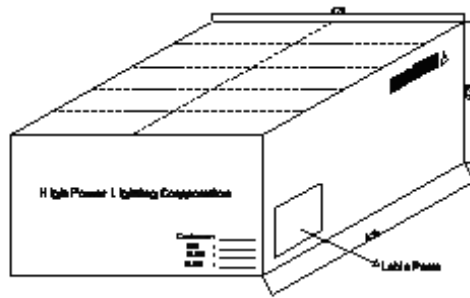
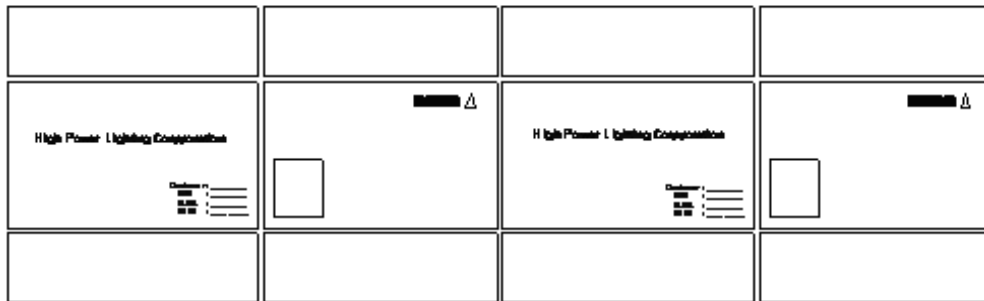
### Label Formation

P/N: XXXXXXXXXXXXX	BIN Rank : XXXXXXXXX
LOT: XXXXXXXXXXXXX	Q'ty : XXXX PCS XXX

75mm\*8mm

**Package  
Large Box**

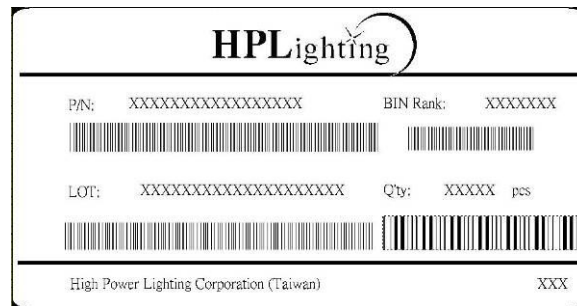
Unit : mm



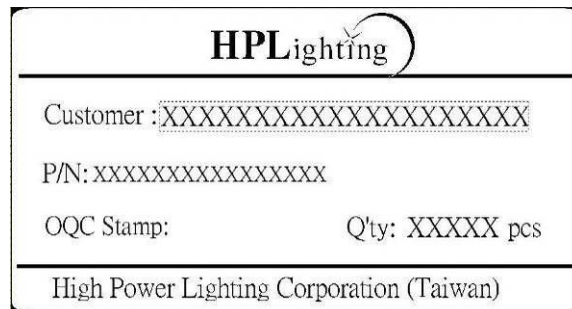
**Label Formation**

70mm

Unit : mm



40mm

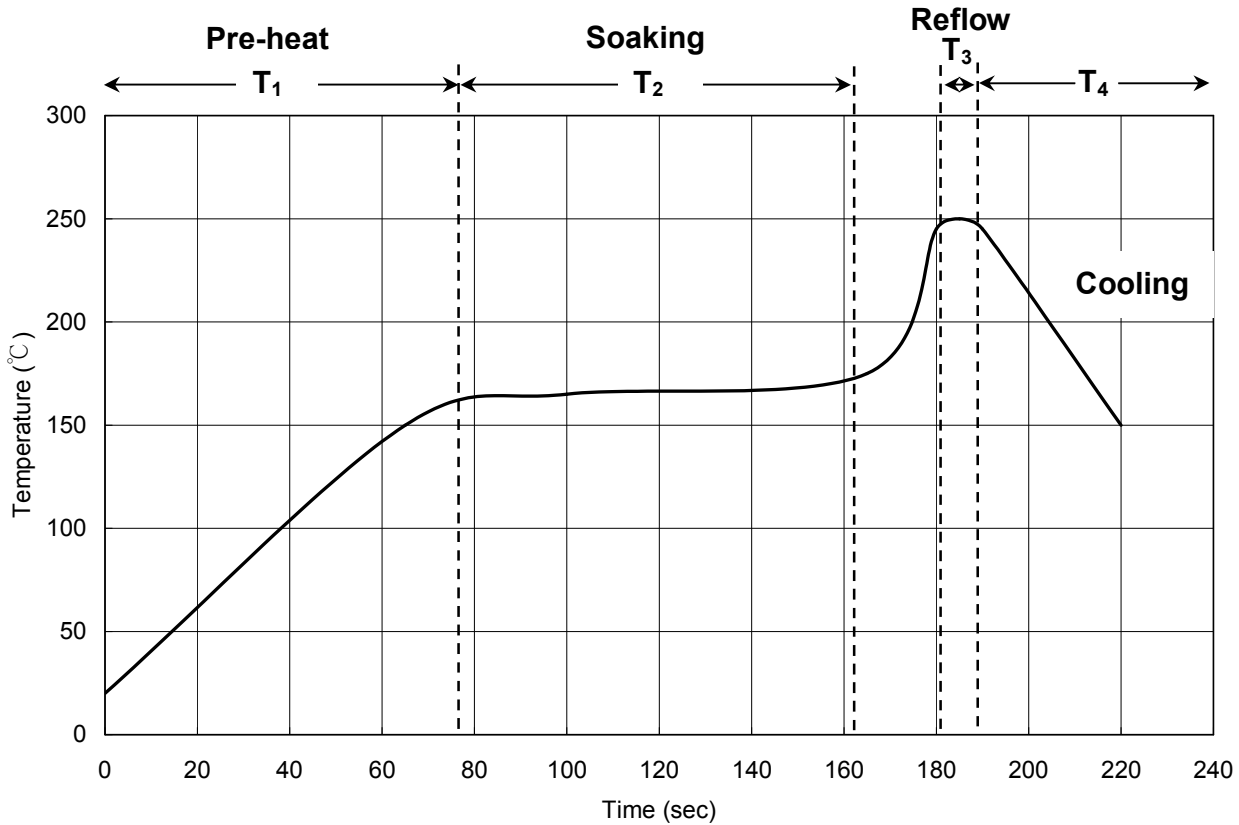


## Qualification Reliability Testing

Classification	Test Item	Test conditions	Reference Standard
Endurance Test	Operation Life	$I_f = 60\text{mA}/120\text{mA}(\text{H28}), 350\text{mA}/700\text{mA}(\text{H40}/\text{H44}/\text{H99})$ $T_a = 25^\circ\text{C}$ Test Duration = 1000hrs	MIL-STD-750: 1026 MIL-STD-883: 1005 JIS C 7021: B-1
	High Temperature High Humidity Storage	$T_a = 85\pm 5^\circ\text{C}$ RH = 85±5% Test Duration = 1000hrs	MIL-STD-202: 103B JIS C 7021: B-11
	High Temperature Storage	$T_a = 105\pm 5^\circ\text{C}$ Test Duration = 1000hrs	MIL-STD-202: 1008 JIS C 7021: B10
	Low Temperature Storage	$T_a = -40\pm 5^\circ\text{C}$ Test Duration = 1000hrs	JIS C 7021: B-12
Environmental Test	Temperature Cycling	$-40^\circ\text{C} \sim 25^\circ\text{C} \sim 105^\circ\text{C} \sim 25^\circ\text{C}$ 30min 5min 30min 5min Test Duration = 10 cycle	MIL-STD-202: 107D MIL-STD-750: 1051 MIL-STD-883: 1010 JIS C 7021: A-4
	Thermal Shock	$-55\pm 5^\circ\text{C} \sim 105\pm 5^\circ\text{C}$ 30min 30min Test Duration = 10 cycle	MIL-STD-202: 107D MIL-STD-750: 1051 MIL-STD-883: 1011
	Solder Resistance	$T_{\text{sol}} = 260\pm 5^\circ\text{C}$ Dwell Time = 10sec	MIL-STD-202: 210A MIL-STD-750: 2031 JIS C 7021: A-1
Measuring Items	Symbol	Measuring Conditions	Failure Criteria
Forward voltage	$V_f$	$I_f = 60\text{mA}/120\text{mA}(\text{H28}), 350\text{mA}/700\text{mA}(\text{H40}/\text{H44}/\text{H99})$	$V_f$ shift > 10%
Luminous	$I_v\%$	$I_f = 60\text{mA}/120\text{mA}(\text{H28}), 350\text{mA}/700\text{mA}(\text{H40}/\text{H44}/\text{H99})$	$I_v\%$ shift > 10%

## Recommended Solder Profile

**Soldering** Recommended soldering conditions:



T <sub>1</sub>	Ramp up rate	1.0 ~ 3.0 °C/sec
	Pre-heat time	50 ~ 80 sec
T <sub>2</sub>	Soaking temperature	155 ~ 185 °C
	Dwell time during soaking	60 ~ 120 sec
T <sub>3</sub>	Reflow temperature	240 ~ 250 °C
	Reflow time	Max 10 sec
	Ramp up rate during reflow	1.2 ~ 2.3 °C/sec
T <sub>4</sub>	Cooling	1.0 ~ 6.0 °C/sec

Note: Suggest using Sn96Ag3Cu0.5 lead free solder.

### Cleaning

Use alcohol-based cleaning solvents such as isopropyl alcohol to clean the LED if necessary.





**This page is intended left blank.**

For the latest product information, call us or visit: [www.hplighting.com.tw](http://www.hplighting.com.tw)

©2015, High Power Lighting Corporation(HPL), all rights reserved. This document contains information that is proprietary to HPL and may be duplicated in whole or in part by the original recipient for the internal business purposes only, provided that this entire notice appears in all copies. In accepting this document, the recipient agrees to make every reasonable effort to prevent unauthorized use of this information.

5F, No 173-8, Yung-Fon Road, Tu-Cheng District, New Taipei City, Taiwan, R.O.C.  
TEL: +886-2-8262-8886 FAX : +886-2-8262-8885

**HPLighting Corp.**

[www.hplighting.com.tw](http://www.hplighting.com.tw)

The information in this document is subject to change without notice.

**HPL-H44LV1CQ**  
- 25/25 --