

Specification For UV Series

HPL-H44RU1C0



Features

- High Efficacy 3W UV LED
- Dimension : 4.4mm(L)×4.4mm(W)
- All Metal Design Cu Substrate/Al reflector with Quartz Glass Lens
- View Angle 60°
- Low thermal resistance
- The InGaN Chip inside
- Superior ESD protection

Applications

- UV Printing/UV Curing
- Medical
- Electronics Assembly
- Opto Electronics
- Special Lighting
- Defect Detection

5F, No 173-8, Yung-Fon Road, Tu-Cheng District, New Taipei City, Taiwan, R.O.C.
TEL: +886-2-8262-8886 FAX : +886-2-8262-8885

Table of Contents

General Information	3
Part Number Matrix	4
Absolute Maximum Ratings	4
Initial Electrical/Optical Characteristics	5
Forward Voltage	5
Radiant Flux	5
Peak Wavelength	5
Spectra half-width	5
Typical Radiation Pattern	6
Bin Code List for Reference	7
Wavelength Bins	7
Part Number Formation	8
Characteristic Diagram	9
Outline Dimension	13
Pad Configuration	13
Recommended Solder Pattern	15
Shipping Package Style	16
Lens Type	16
Tapping Dimension Packaging Specification	16
Assembly Type	21
Tapping Dimension Packaging Specification	21
Qualification Reliability Testing	24
Recommended Solder Profile	25

General Information

HPL - H44 X₁ X₂ 1 C0

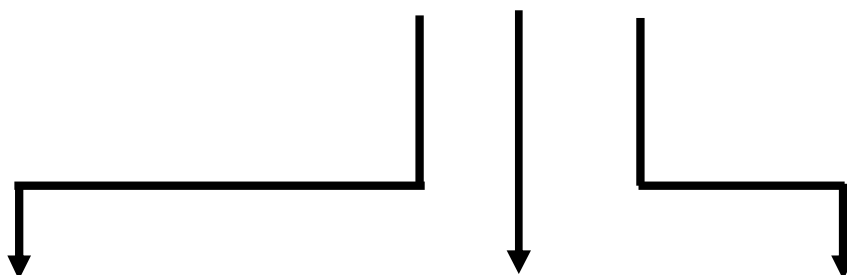

X₁:Lens & Assembly Type-
R : 60° Lens Emitter only
T : 60° Lens Emitter on Standard Star

X₂:Color-
U: UV390~420nm

Power-
C: 3W

Part Number Matrix

Type Wavelength	60°Lens	60°Lens & Star
U	HPL-H44RU1C0	HPL-H44TU1C0

Absolute Maximum Ratings

(T_j=25°C)

Parameter	Symbol	Rating	Unit
Power Dissipation UV390-420nm	P	3	W
Forward Current	I _F	700	mA
Forward Pulse Current (1/10 Duty Cycle, 400msec Pulse Width)	I _{FP}	1000	mA
Thermal Resistance, Junction-Case	R _{th, J-C1}	5	°C/W
LED Junction Temperature	T _J	125	°C
Operating Temperature Range	T _{opr}	- 40°C to + 80°C	
Storage Temperature Range	T _{stg}	- 40°C to + 120°C	
Soldering Condition	T _{sol}	260°C For 5 Seconds	

Note: 1. The thermal resistance value is measured with MCPCB (Star).

Initial Electrical/Optical Characteristics

- Forward Voltage** (T_j=25°C)

Wavelength	Forward Voltage					
	Symbol	MIN.	TYP.	MAX.	Test Condition	Unit
390~420nm	V _F	3.03	3.8	4.47	I _F = 700mA	V

Caution: The real output is decided by chip capability

- Radiant Flux**(T_j=25°C)

Wavelength	Radiant Flux					
	Symbol	MIN.	TYP.	MAX.	Test Condition	Unit
410~420nm	Φ _e	500	850	-	I _F = 700mA	mW
400~410nm		500	850	-		
390~400nm		500	850	-		

Caution: The real output is decided by chip capability

- Peak wavelength** (T_j=25°C)

Wavelength	Wavelength					
	Symbol	MIN.	TYP.	MAX.	Test Condition	Unit
390~420nm	λ _p	390	-	420	I _F = 700mA	nm

- Spectra half-width** (T_j=25°C)

Wavelength	Wavelength					
	Symbol	MIN.	TYP.	MAX.	Test Condition	Unit
390~420nm	Δλ	-	15	-	I _F = 700mA	nm

● **Typical Radiation Pattern**

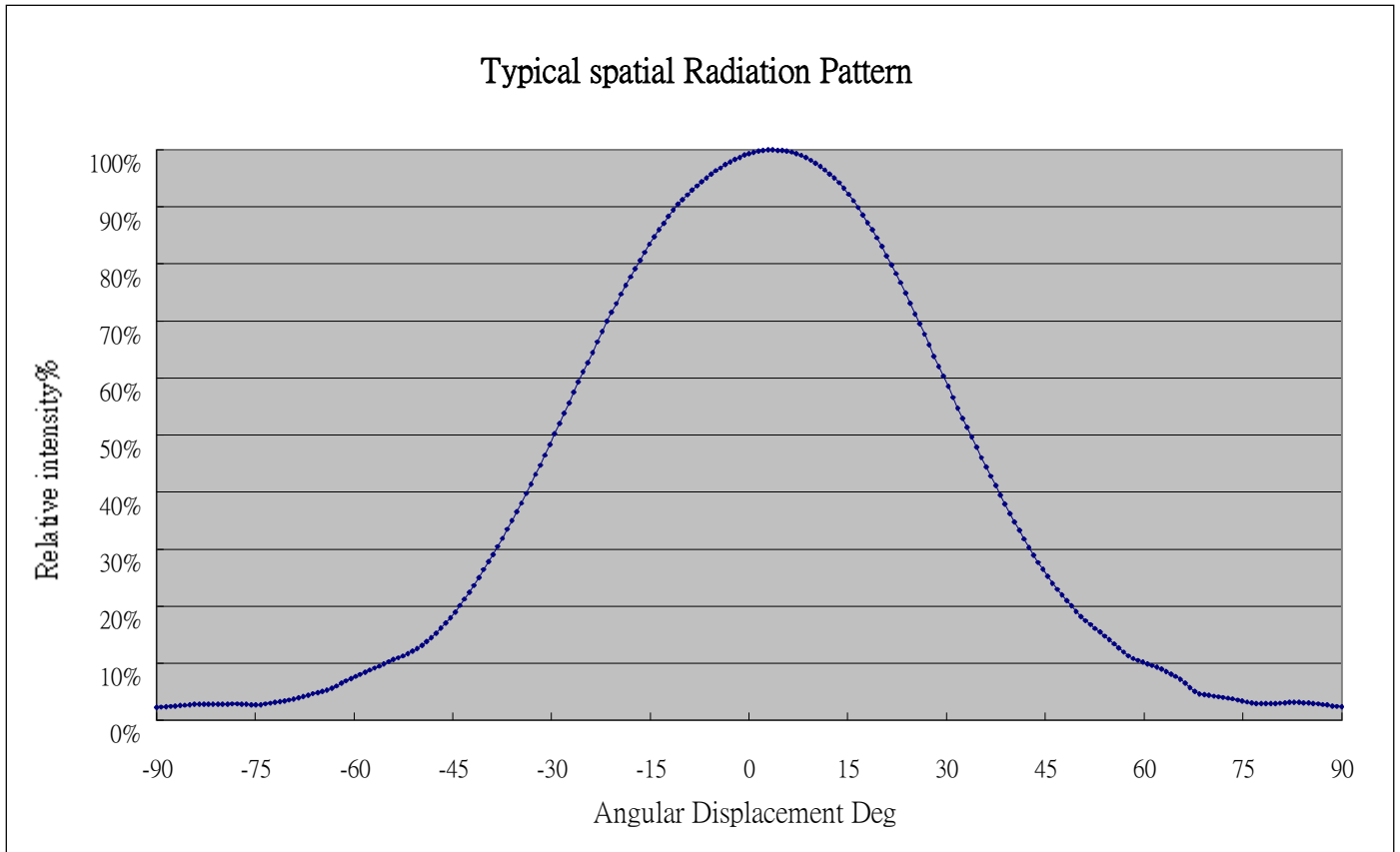

Fig. (60° Lens) Typical Representative Spatial Radiation Pattern

● Bin Code List for Reference

(T_j=25°C)

Item	Bin Code	Symbol	Condition	Min.	Max.	Unit
Forward Voltage ¹	H	V _F	I _F = 700 [mA]	3.03	3.27	V
	J			3.27	3.51	
	K			3.51	3.75	
	L			3.75	3.99	
	M			3.99	4.23	
	N			4.23	4.47	
Radiant Flux ²	D	Φ _e	I _F = 700 [mA]	350	425	mW
	E			425	500	
	F			500	600	
	G			600	700	
	H			700	800	
	J			800	900	

● Wavelength Bins

Wavelength ³	Bin Code	Symbol	Condition	Min.	Max.	Unit
U 390~420nm	UF	λ _p	I _F = 700 [mA]	415	420	nm
	UE			410	415	
	UD			405	410	
	UC			400	405	
	UB			395	400	
	UA			390	395	

Note

1. Forward voltage measurement allowance is ± 0.1V.
2. Radiant flux measurement allowance is ± 10%.
3. Wavelength measurement allowance is ± 2nm.

Part Number Formation

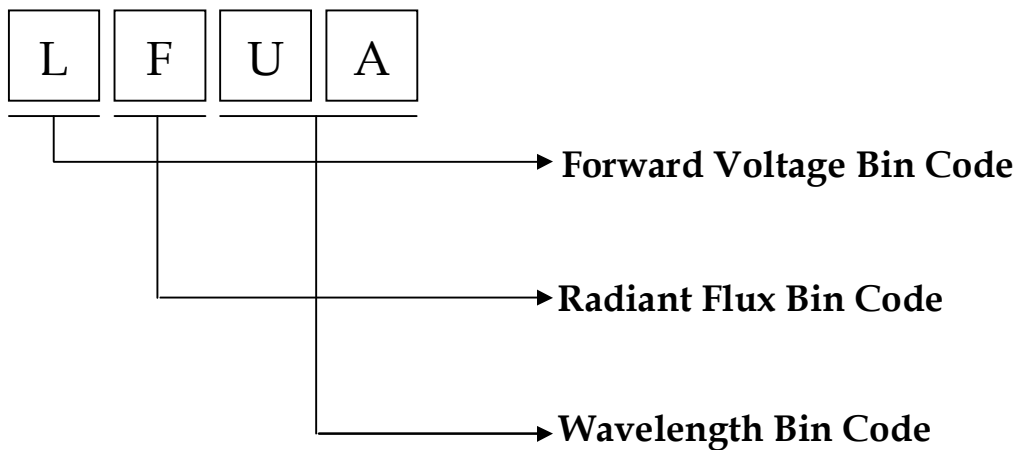
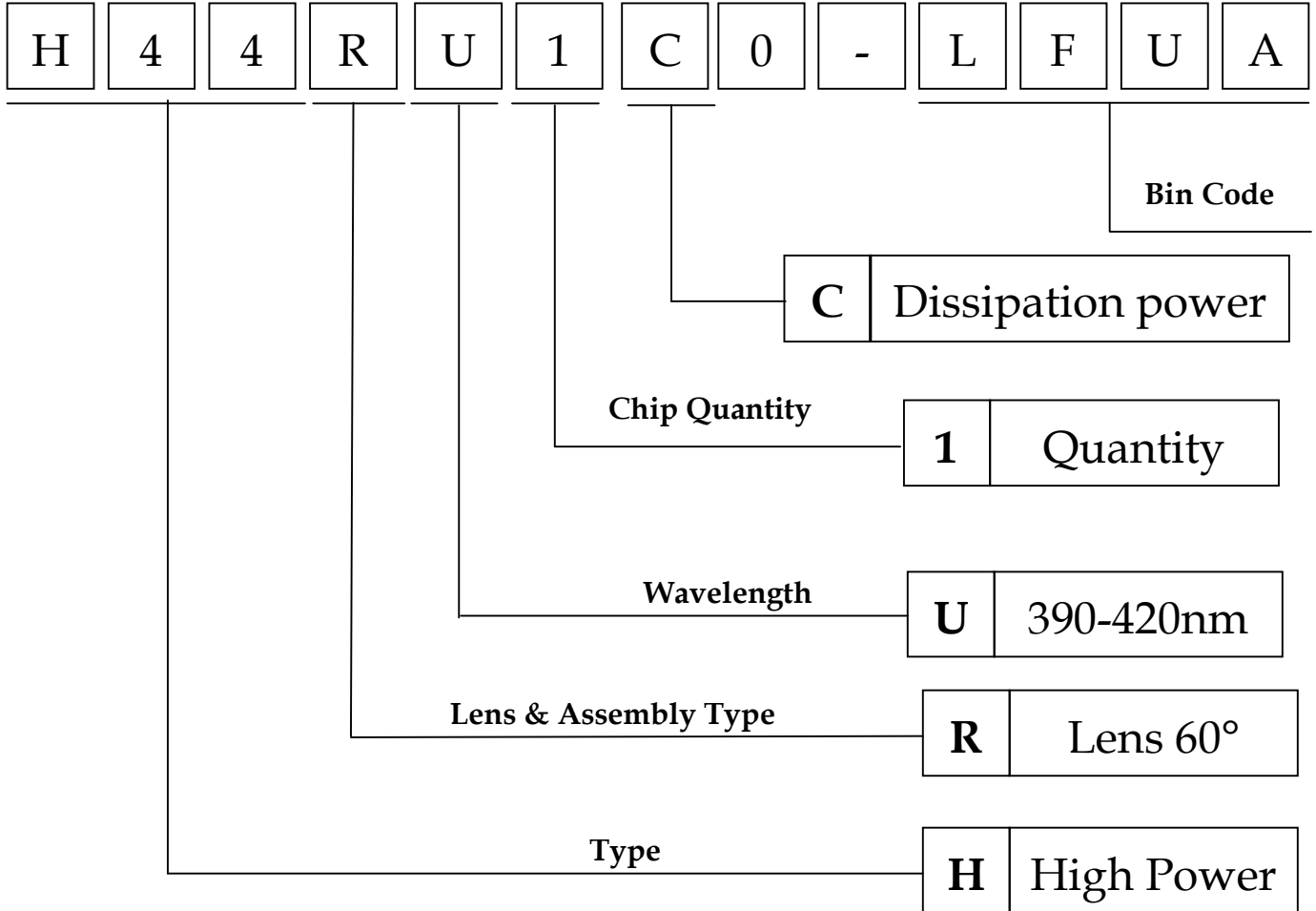

Characteristic Diagram

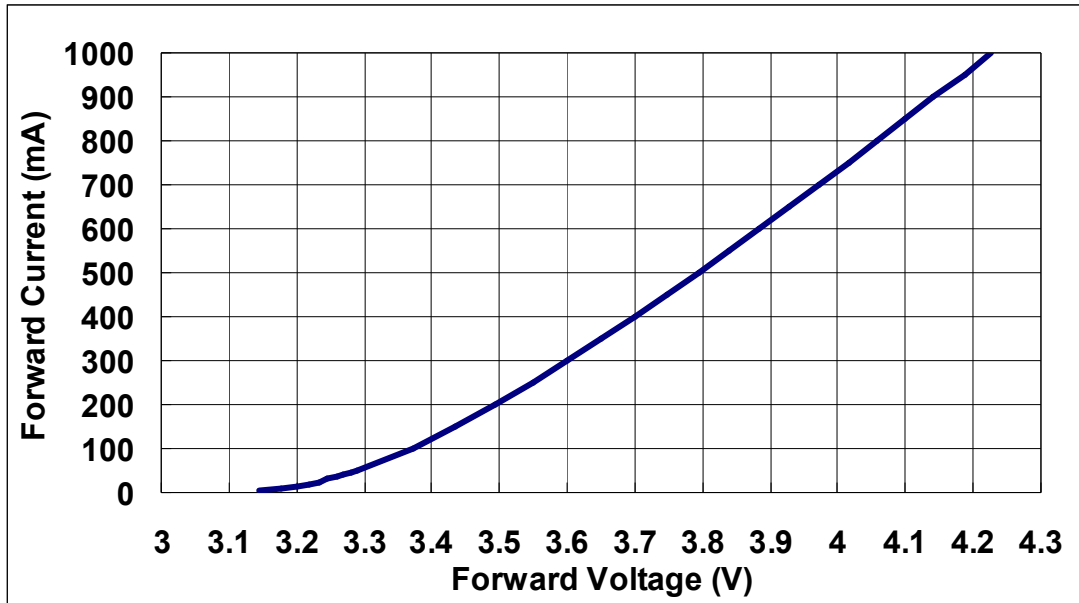

Fig. Forward Current vs. Forward Voltage

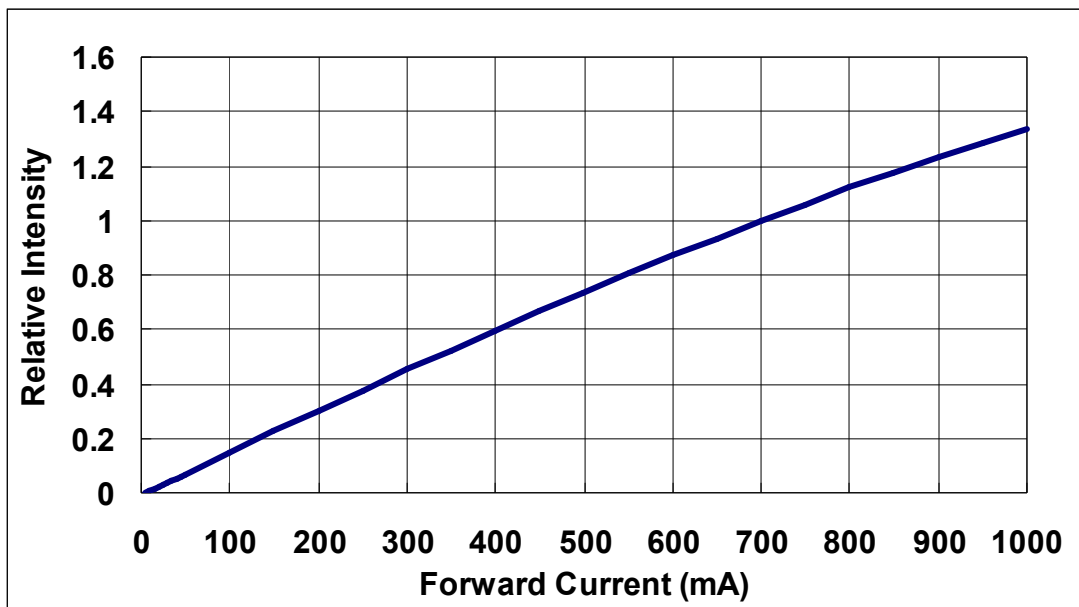

Fig. Relative Intensity vs. Forward Current.

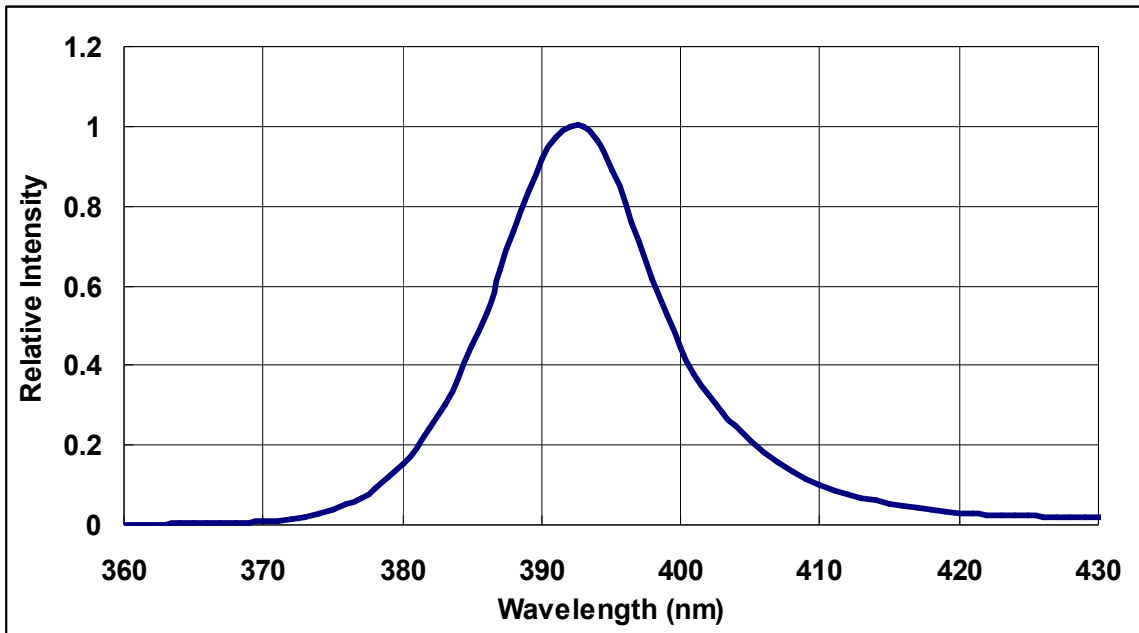

Fig. Typical Relative Intensity vs. wavelength

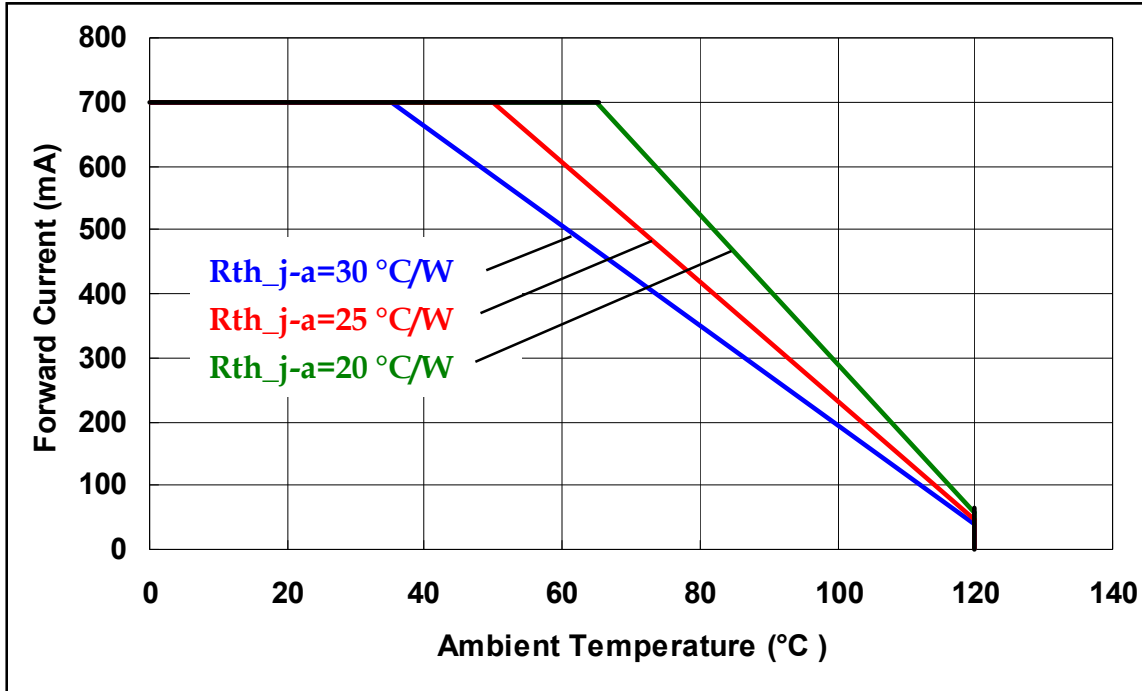

Fig. Forward Current Degrading Curve

Note:

R_{th_j-a} : junction to Ambient Thermal Resistance

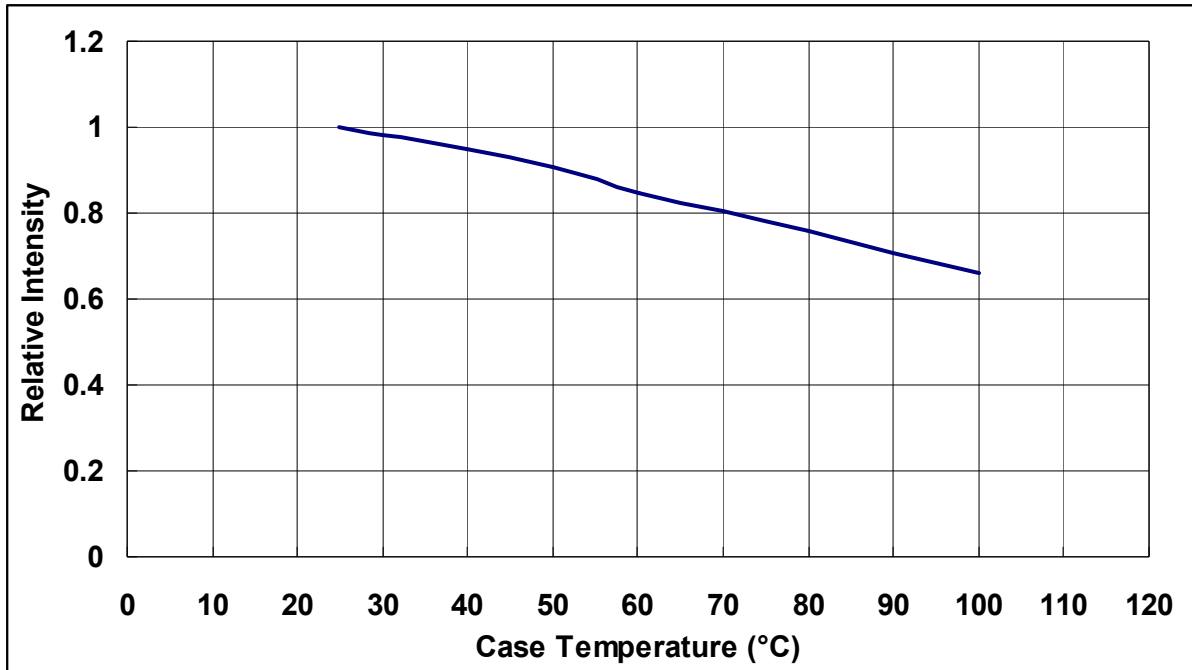

Fig. Relative Intensity vs. Case Temperature

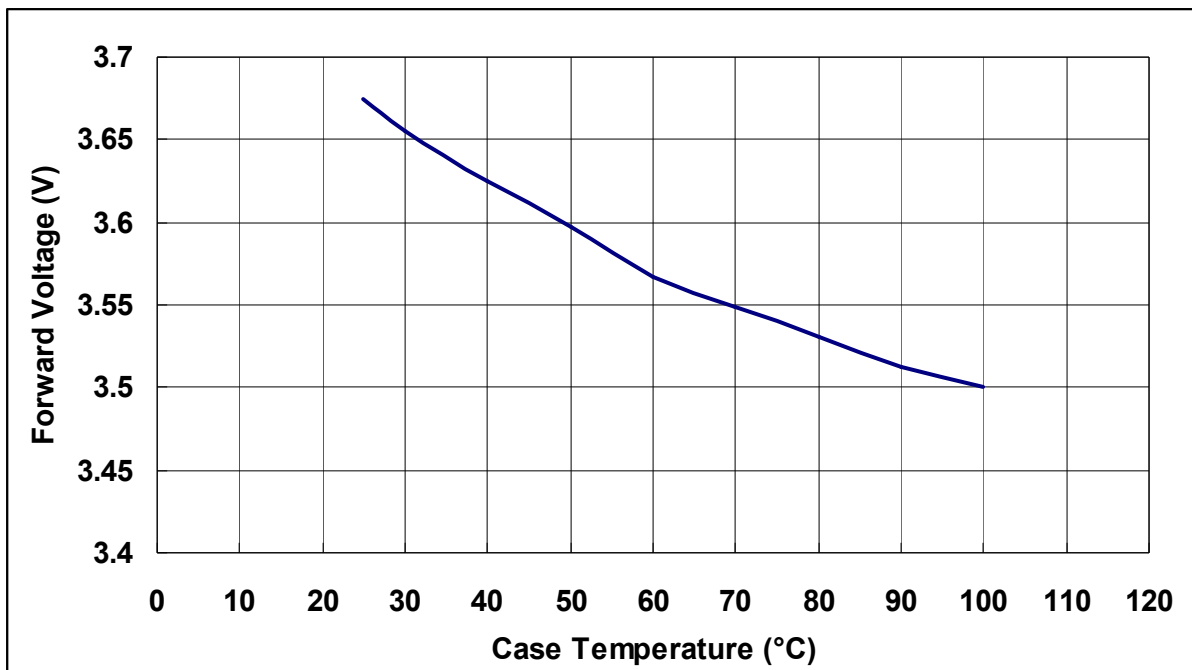

Fig. Forward Voltage vs. Case Temperature

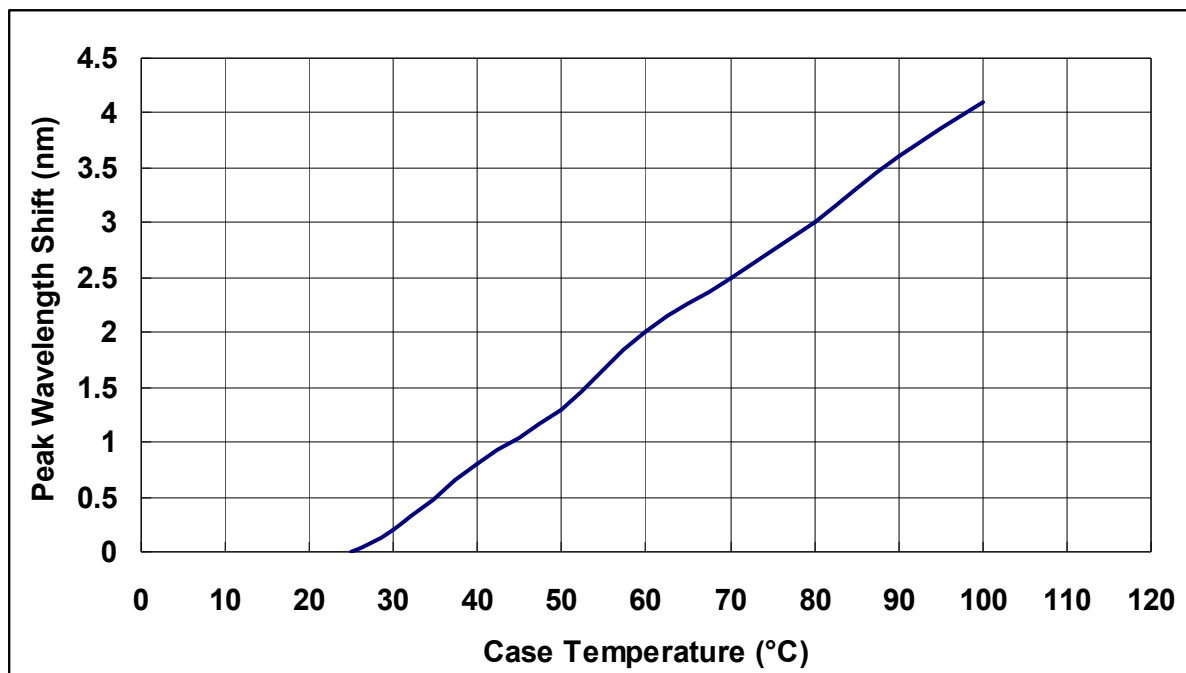

Fig. Peak Wavelength shift vs. Case Temperature

Outline Dimension

HPL-H44RU1C0

Unit : mm

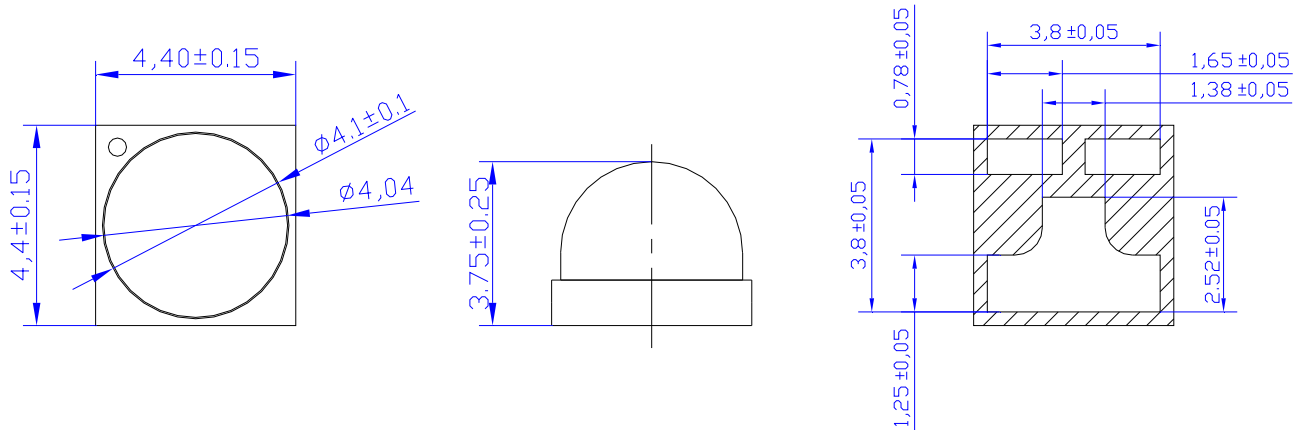
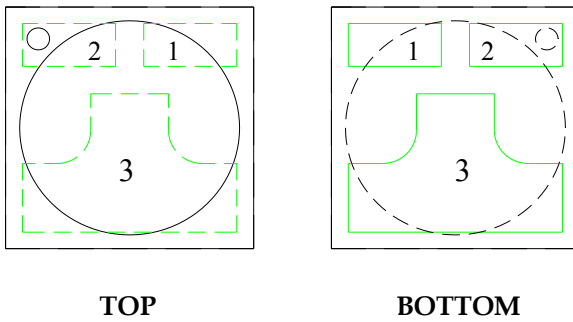

Fig. Package Outline Drawing.

Pad Configuration



PAD	Function
1	Cathode
2	Anode
3	Thermal

Fig. Pad configuration.

HPL-H44TU1C0

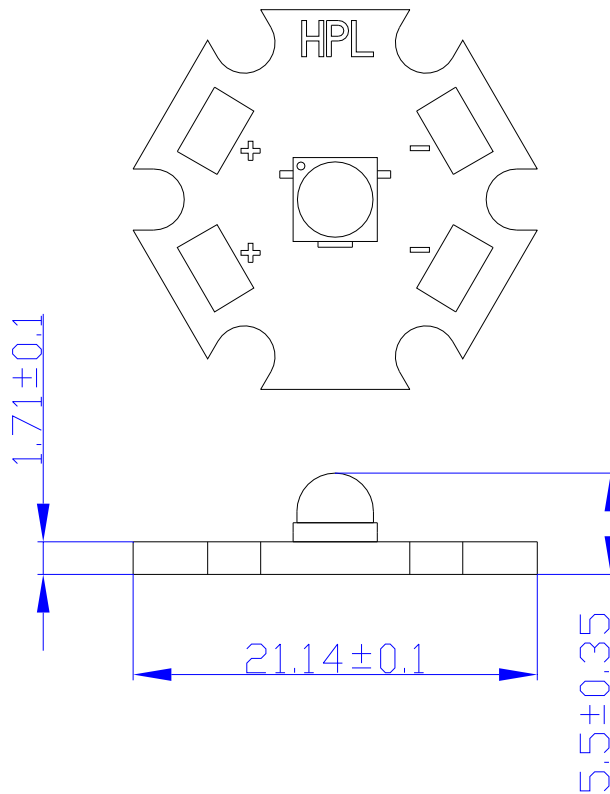
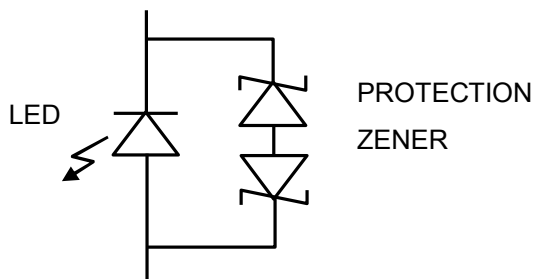
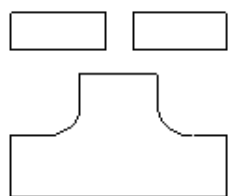
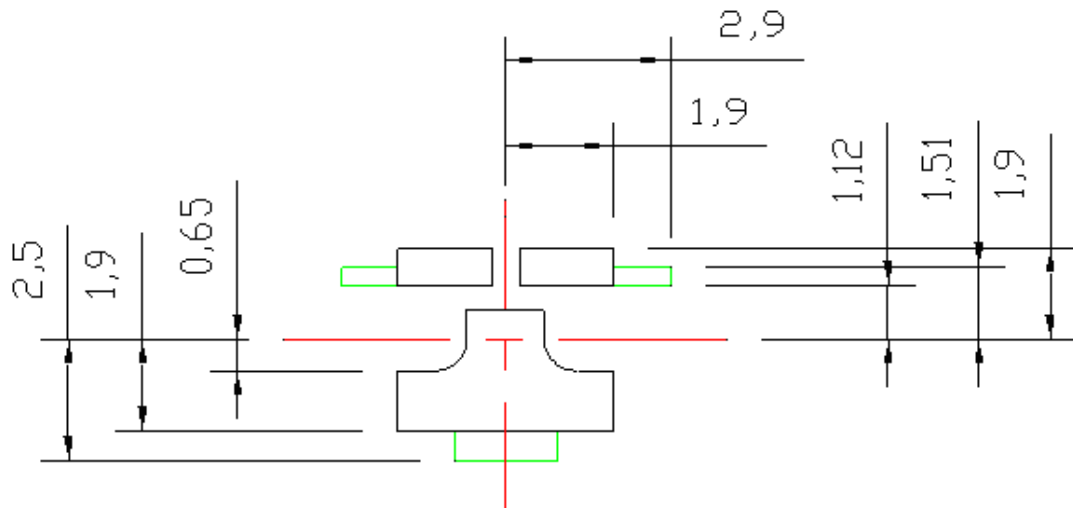

Fig. Assembly r Outline Drawing.

PROTECTION CIRCUIT



Recommended Solder Pattern



**SOLDER
MASK**

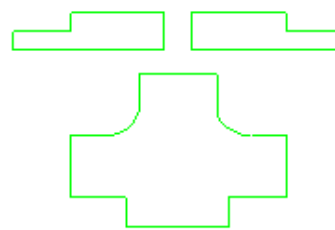

**COPPER
LAYER**

Fig. Solder Pad Layout.

Shipping Package Style

Lens Type

Tapping Dimension Packaging Specification

60 Degree Lens Type :

- Moisture proof bag.
- 1 Reel/bag.
- Q'ty: 650 (MAX)/Reel.

Unit : mm

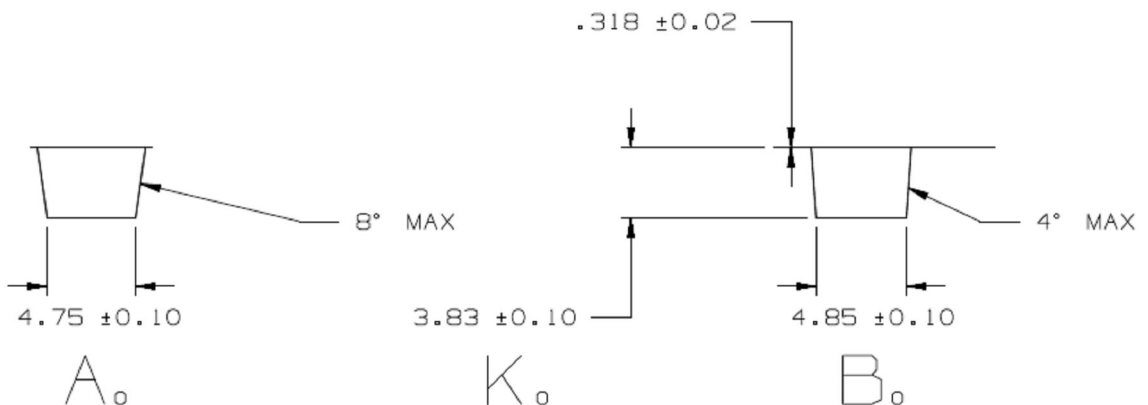
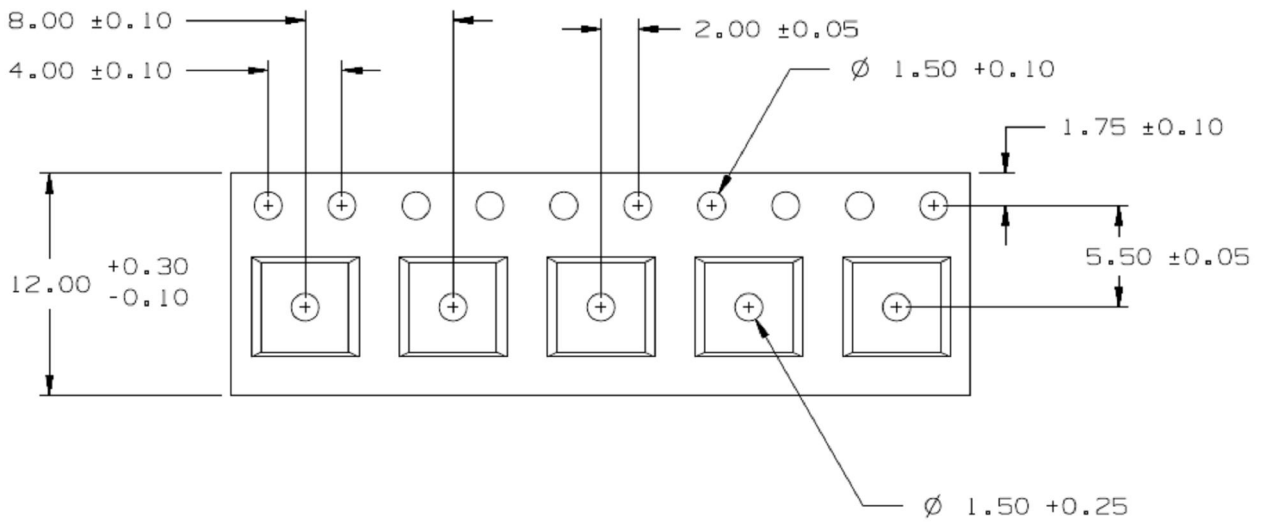

Label Formation

P/N: XXXXXXXXXXXXXXXX	BIN Rank : XXXXXXXXXXXX
LOT: XXXXXXXXXXXXXXXX	Q'ty : XXXX PCS XXX

75mm*8mm

Package

Box Type	Dimension (mm)	Reel/Box	60°Lens Type (Pcs)
Small Box(S)	230x85x265	5 Reel/Box	3250
Middle Box(M)	470x265x270	30 Reel/Box	19500
Large Box(L)	470x435x270	50 Reel/Box	32500

Reel Packaging :

Reel Part :

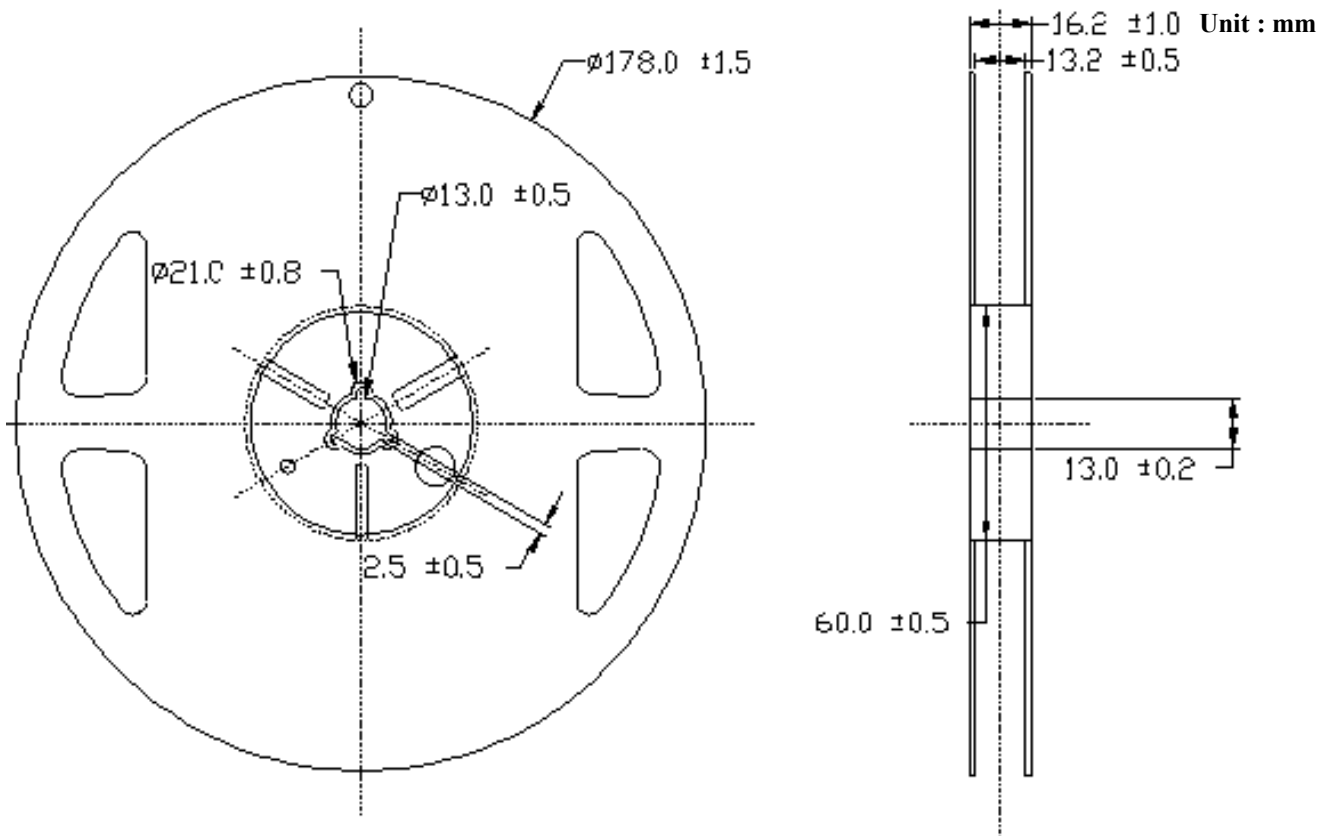

Anti Statistic Bag :

Unit : mm

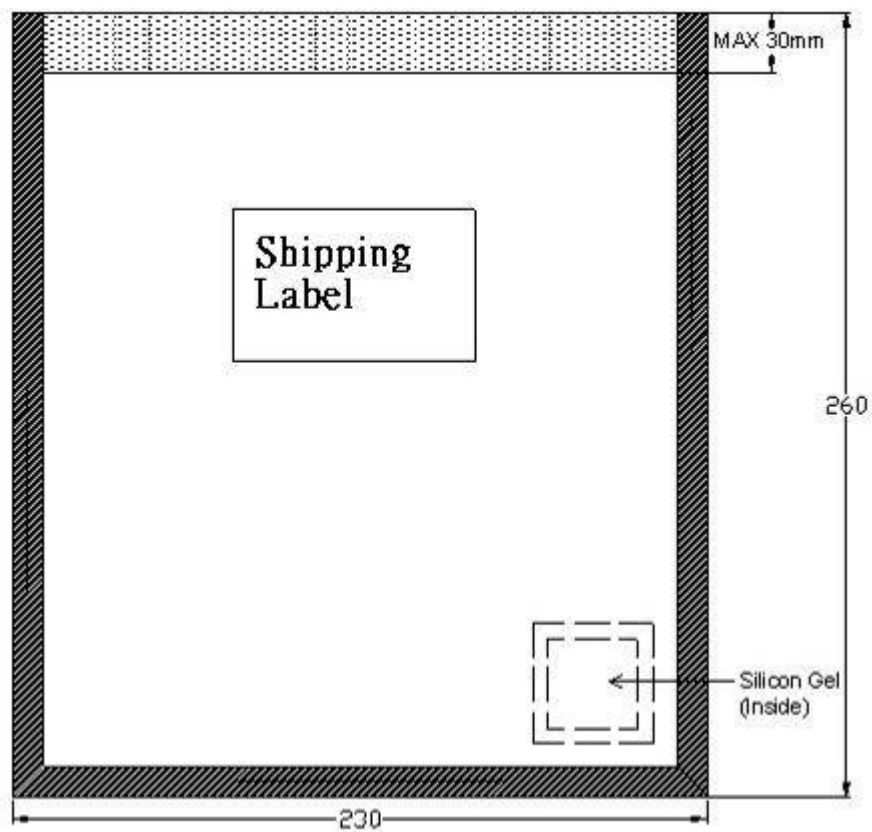

Small Box

Unit : mm

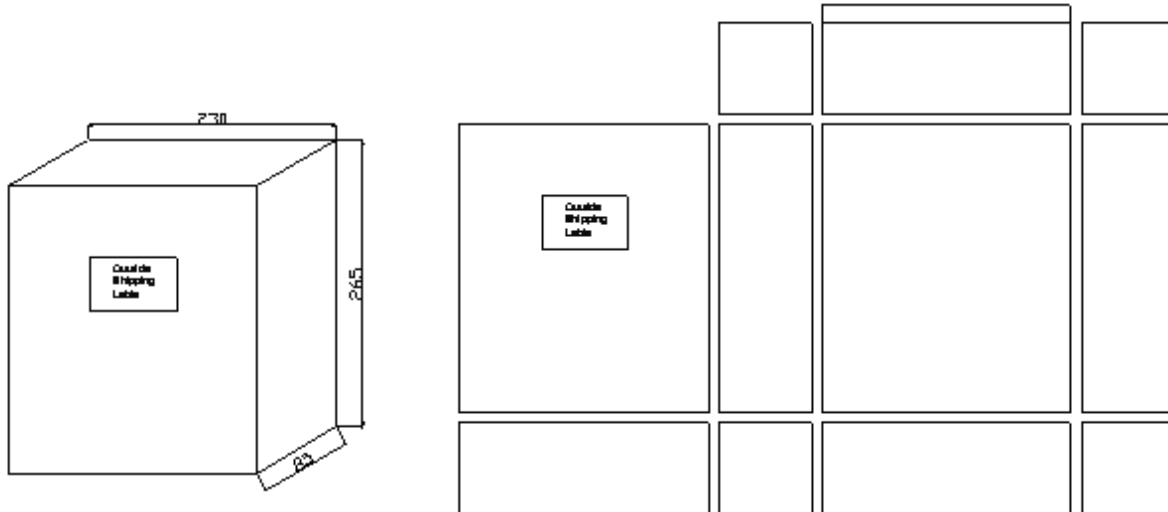

Middle Box

Unit : mm

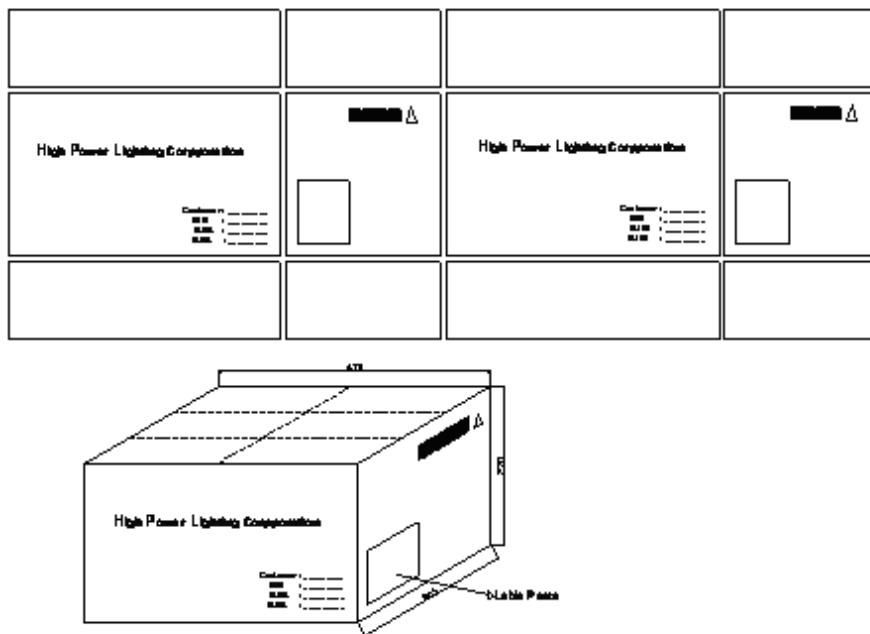

Large Box

Unit : mm

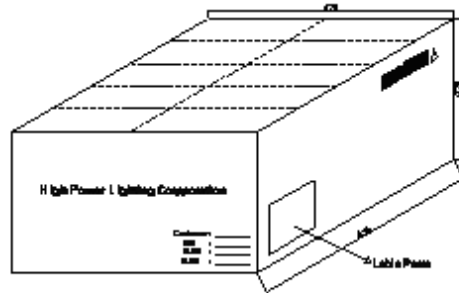
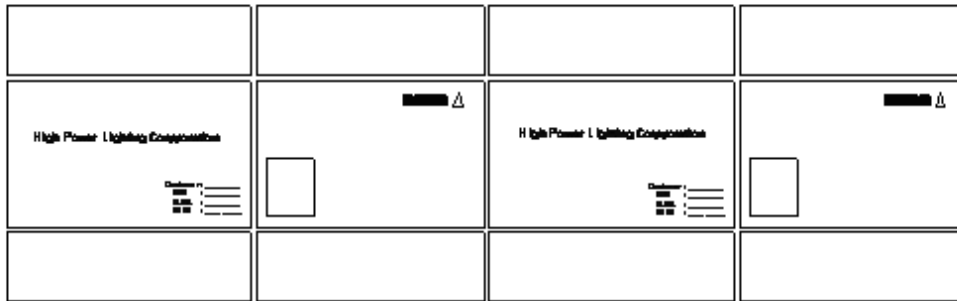

Label Formation

70mm

Unit : mm

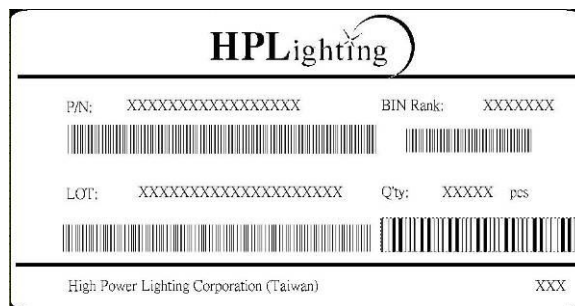

40mm

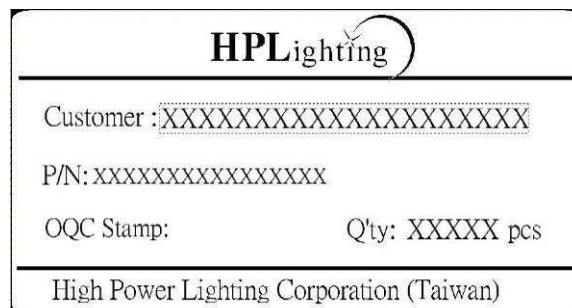

Assembly Type

Tapping Dimension Packaging Specification

60 Degree Assembly Type :

- Moisture proof bag.
- 21 Tray (MAX) /bag.
- Q'ty: 48pcs(MAX)/Tray

Unit : mm

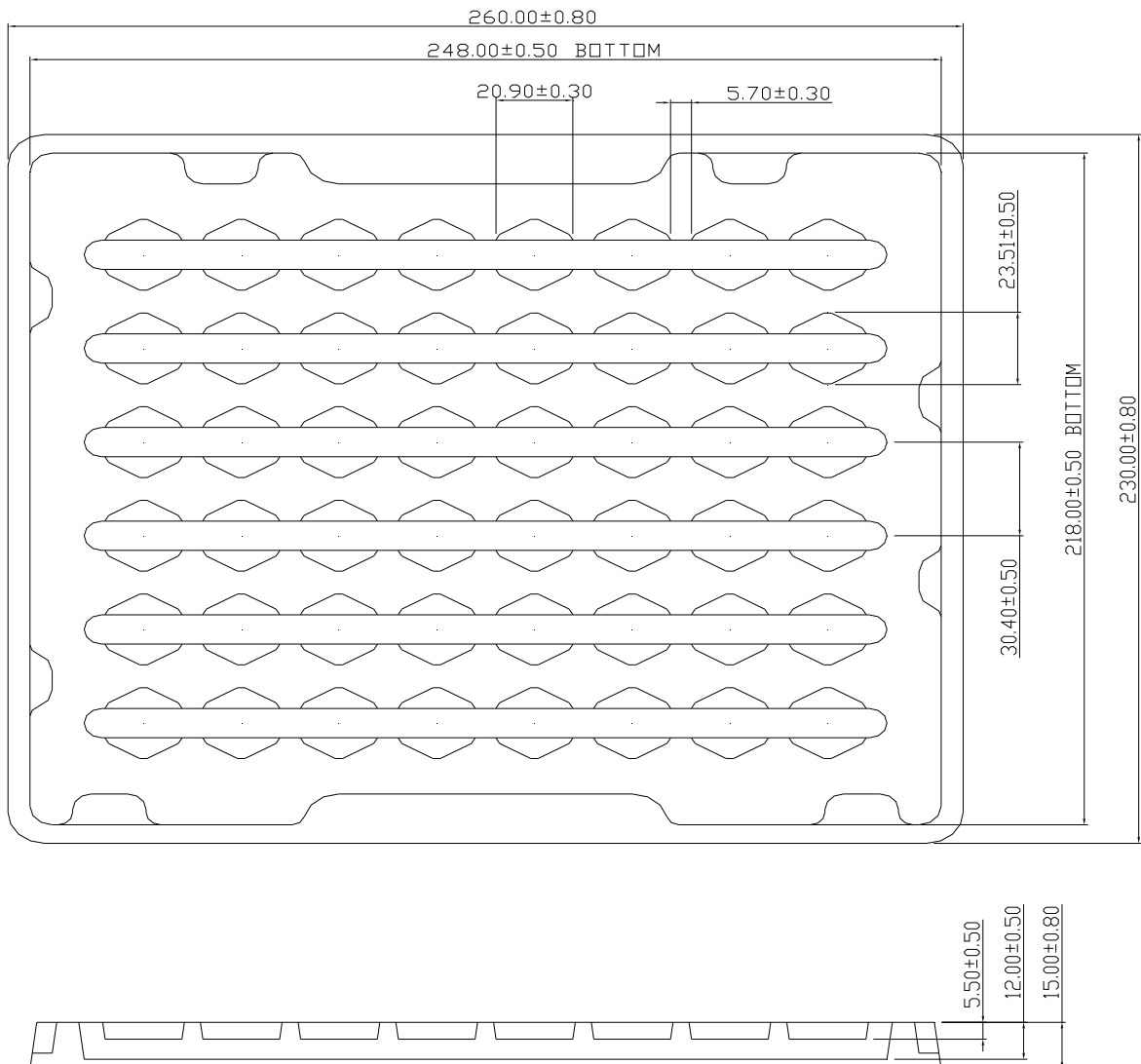

60 Degree Assembly Type :

- 1 Tube
- Q'ty:20pcs(MAX)/Tube
- Q'ty: 300 Tube (MAX)/Box

Unit : mm

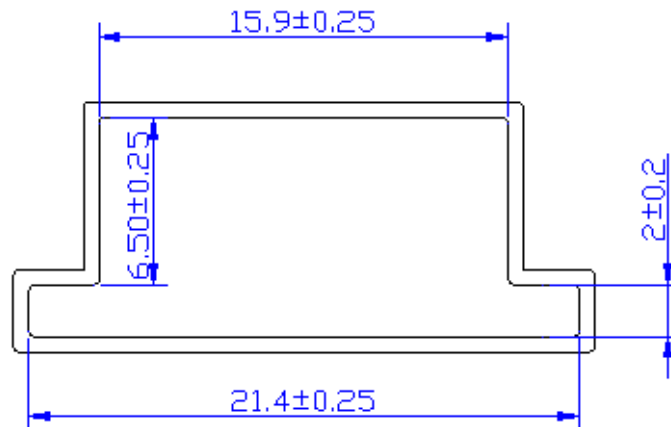

NOTES:

General tolerance=± 0.25mm
Material :PVC,Clear
THICKNESS : 0.60±0.1
LENGTH : 424±2mm

Label Formation

P/N: XXXXXXXXXXXXX	BIN Rank : XXXXXXXXX
LOT: XXXXXXXXXXXXX	Q'ty : XXXX PCS XXX

75mm*8mm

**Package
Large Box**

Unit : mm

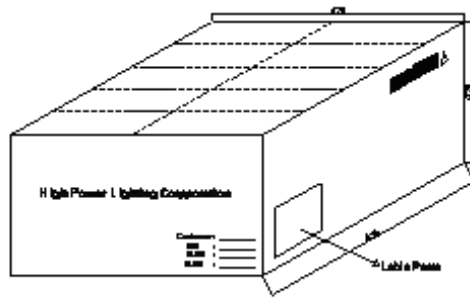
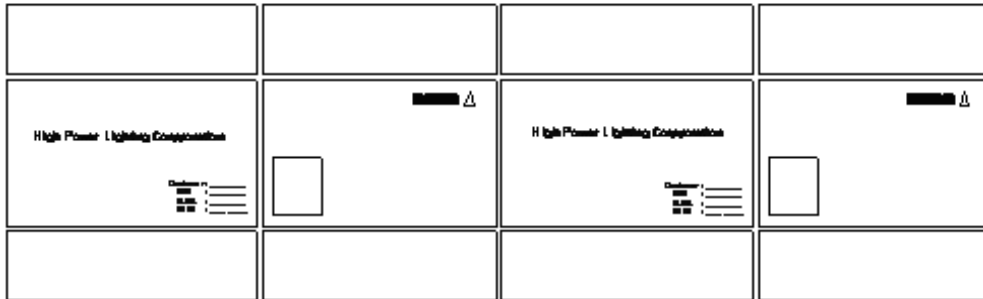

Label Formation

70mm

Unit : mm

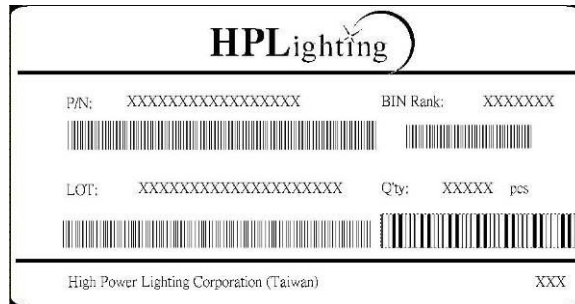

40mm

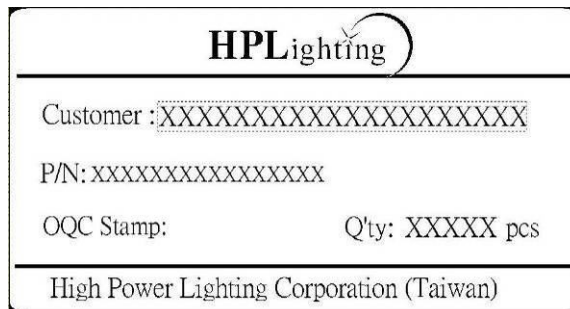

Qualification Reliability Testing

Classification	Test Item	Test conditions	Reference Standard
Endurance Test	Operation Life	$I_f = 60\text{mA}/120\text{mA}(\text{H28}), 350\text{mA}/700\text{mA}(\text{H40}/\text{H44}/\text{H99})$ $T_a = 25^\circ\text{C}$ Test Duration = 1000hrs	MIL-STD-750: 1026 MIL-STD-883: 1005 JIS C 7021: B-1
	High Temperature High Humidity Storage	$T_a = 85\pm 5^\circ\text{C}$ RH = 85±5% Test Duration = 1000hrs	MIL-STD-202: 103B JIS C 7021: B-11
	High Temperature Storage	$T_a = 105\pm 5^\circ\text{C}$ Test Duration = 1000hrs	MIL-STD-202: 1008 JIS C 7021: B10
	Low Temperature Storage	$T_a = -40\pm 5^\circ\text{C}$ Test Duration = 1000hrs	JIS C 7021: B-12
Environmental Test	Temperature Cycling	$-40^\circ\text{C} \sim 25^\circ\text{C} \sim 105^\circ\text{C} \sim 25^\circ\text{C}$ 30min 5min 30min 5min Test Duration = 10 cycle	MIL-STD-202: 107D MIL-STD-750: 1051 MIL-STD-883: 1010 JIS C 7021: A-4
	Thermal Shock	$-55\pm 5^\circ\text{C} \sim 105\pm 5^\circ\text{C}$ 30min 30min Test Duration = 10 cycle	MIL-STD-202: 107D MIL-STD-750: 1051 MIL-STD-883: 1011
	Solder Resistance	$T_{\text{sol}} = 260\pm 5^\circ\text{C}$ Dwell Time = 10sec	MIL-STD-202: 210A MIL-STD-750: 2031 JIS C 7021: A-1
Measuring Items	Symbol	Measuring Conditions	Failure Criteria
Forward voltage	V_f	$I_f = 60\text{mA}/120\text{mA}(\text{H28}), 350\text{mA}/700\text{mA}(\text{H40}/\text{H44}/\text{H99})$	V_f shift > 10%
Luminous	$I_v\%$	$I_f = 60\text{mA}/120\text{mA}(\text{H28}), 350\text{mA}/700\text{mA}(\text{H40}/\text{H44}/\text{H99})$	$I_v\%$ shift > 10%

Recommended Solder Profile

Soldering Recommended soldering conditions:

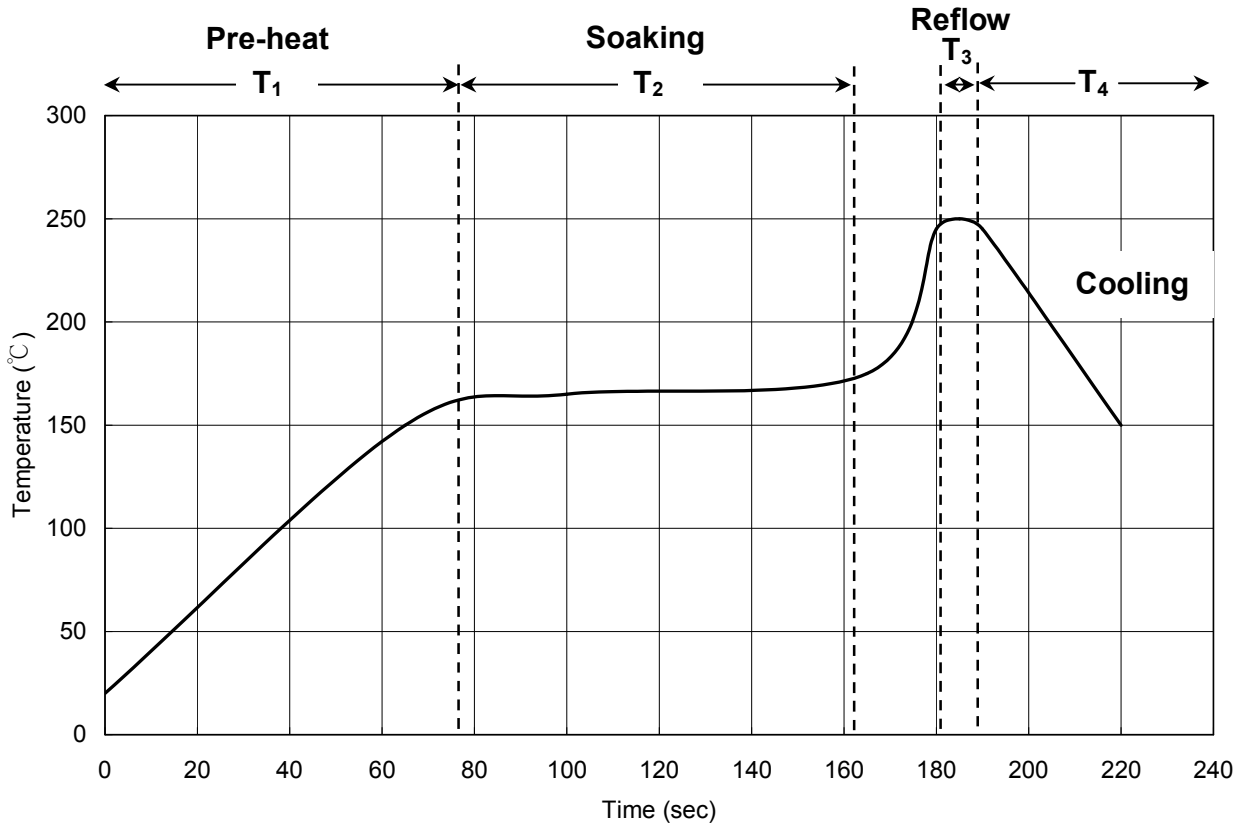

T ₁	Ramp up rate	1.0 ~ 3.0 °C/sec
	Pre-heat time	50 ~ 80 sec
T ₂	Soaking temperature	155 ~ 185 °C
	Dwell time during soaking	60 ~ 120 sec
T ₃	Reflow temperature	240 ~ 250 °C
	Reflow time	Max 10 sec
	Ramp up rate during reflow	1.2 ~ 2.3 °C/sec
T ₄	Cooling	1.0 ~ 6.0 °C/sec

Note: Suggest using Sn96Ag3Cu0.5 lead free solder.

Cleaning

Use alcohol-based cleaning solvents such as isopropyl alcohol to clean the LED if necessary.



This page is intended left blank.

For the latest product information, call us or visit: www.hplighting.com.tw

©2015, High Power Lighting Corporation(HPL), all rights reserved. This document contains information that is proprietary to HPL and may be duplicated in whole or in part by the original recipient for the internal business purposes only, provided that this entire notice appears in all copies. In accepting this document, the recipient agrees to make every reasonable effort to prevent unauthorized use of this information.

5F, No 173-8, Yung-Fon Road, Tu-Cheng District, New Taipei City, Taiwan, R.O.C.
TEL: +886-2-8262-8886 FAX : +886-2-8262-8885

HPLighting Corp.

www.hplighting.com.tw