

Specification For IR Series

HPL-H40DJ1C4

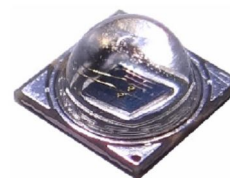

Features

- Dimension : 4.0mm(L)×4.0mm(W)
- High Radiant Flux type
- All Metal Design Cu Substrate with Silicone Lens
- Exceed narrow beam angle 40°
- Low thermal resistance
- The AlGaAs/ AlGaAs , AlGaAs/ GaAs Chip inside

Applications

- IrDA
- Encoder
- Data Communication
- CCTV

5F, No 173-8, Yung-Fon Road, Tu-Cheng District, New Taipei City, Taiwan, R.O.C.
TEL: +886-2-8262-8886 FAX : +886-2-8262-8885

Table of Contents

General Information	3
Part Number Matrix	4
Absolute Maximum Ratings	4
Initial Electrical/Optical Characteristics	5
Forward Voltage	5
Reverse Current	5
Radiant Flux	5
Radiant Intensity	5
Peak wavelength	5
Spectra half-width	5
Typical Radiation Pattern	6
Bin Code List for Reference	6
Part Number Formation	7
Characteristic Diagram	8
Outline Dimension	10
Pad Configuration	10
Recommended Solder Pattern	12
Shipping Package Style	13
Qualification Reliability Testing	23
Recommended Solder Profile	24

General Information

HPL - H40DJ1C4

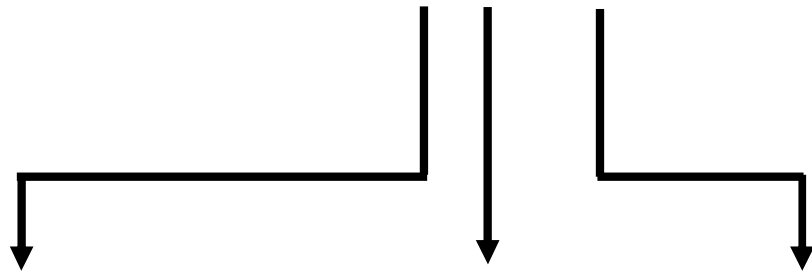

Beam Angle-

Exceed narrow beam angle

Wavelength-

J : IR 850nm

Power-

C : 3W



Part Number Matrix

Type Wavelength	40° Lens	40° Lens & Star
IR 850	HPL-H40DJ1C4	HPL-H40XJ1C4

Absolute Maximum Ratings

(T_j=25°C)

Parameter	Symbol	Rating	Unit
Power Dissipation	P	2.5	W
Forward Current	I _F	1000	mA
Forward Pulse Current (1/10 Duty Cycle, 400msec Pulse Width)	I _{FP}	1500	mA
Thermal Resistance, Junction-Case	R _{th, J-C1}	5	°C/W
Reverse Voltage	V _R	5	V
LED Junction Temperature	T _J	125	°C
Operating Temperature Range	T _{opr}	- 40°C to + 80°C	
Storage Temperature Range	T _{stg}	- 40°C to + 120°C	
Soldering Condition	T _{sol}	260°C For 10 Seconds	

Note: 1. The thermal resistance value is measured with MCPCB (Star).

Initial Electrical/Optical Characteristics

- Forward Voltage** (T_j=25°C)

Wavelength	Forward Voltage					
	Symbol	MIN.	TYP.	MAX.	Test Condition	Unit
IR 850nm	V _F	-	1.9	-	I _F = 1000mA	V

- Reverse Current** (T_j=25°C)

Wavelength	Reverse Current					
	Symbol	MIN.	TYP.	MAX.	Test Condition	Unit
IR 850nm	I _R	-	-	100	V _R = 5V	μA

- Radiant Flux** (T_j=25°C)

Wavelength	Radiant Flux					
	Symbol	MIN.	TYP.	MAX.	Test Condition	Unit
IR 850nm	Φ _e	500	800	-	I _F = 1000mA	mW

- Radiant Intensity** (T_j=25°C)

Wavelength	Radiant Intensity					
	Symbol	MIN.	TYP.	MAX.	Test Condition	Unit
IR 850nm	I _e	-	720	-	I _F = 1000mA	mW/sr

- Peak wavelength** (T_j=25°C)

Wavelength	Wavelength					
	Symbol	MIN.	TYP.	MAX.	Test Condition	Unit
IR 850nm	λ _p	840	855	870	I _F = 1000mA	nm

- Spectra half-width** (T_j=25°C)

Wavelength	Wavelength					
	Symbol	MIN.	TYP.	MAX.	Test Condition	Unit
IR 850nm	Δλ	-	40	-	I _F = 1000mA	nm

● Typical Radiation Pattern

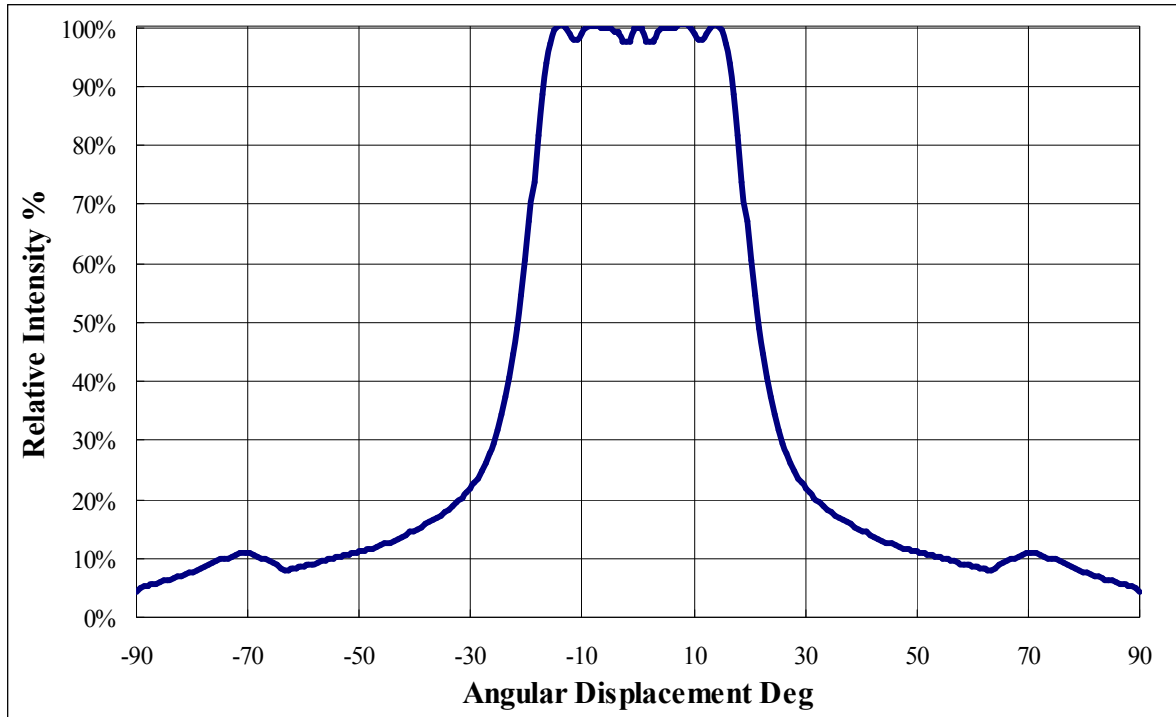

Fig. Typical Representative Spatial Radiation Pattern : 40 degree

● Bin Code List for Reference

(Tj=25°C)

Item	Bin Code	Symbol	Condition	Min.	Max.	Unit
Forward Voltage ¹	B	V _F	I _F = 1000 [mA]	1.59	1.83	V
	C			1.83	2.07	
	D			2.07	2.31	
	E			2.31	2.55	
Luminous Flux ²	F	Φ _e	I _F = 1000 [mA]	500	600	mW
	G			600	700	
	H			700	800	
	J			800	900	

Note

1. Forward voltage measurement allowance is ± 0.1V.
2. Radiant flux measurement allowance is ± 10%.

Part Number Formation

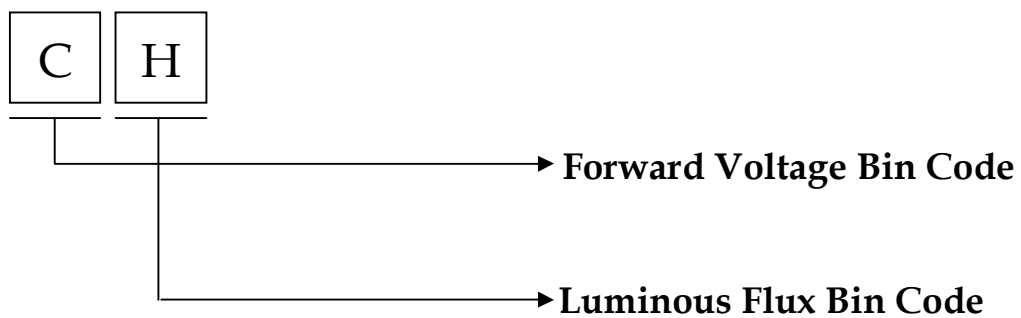
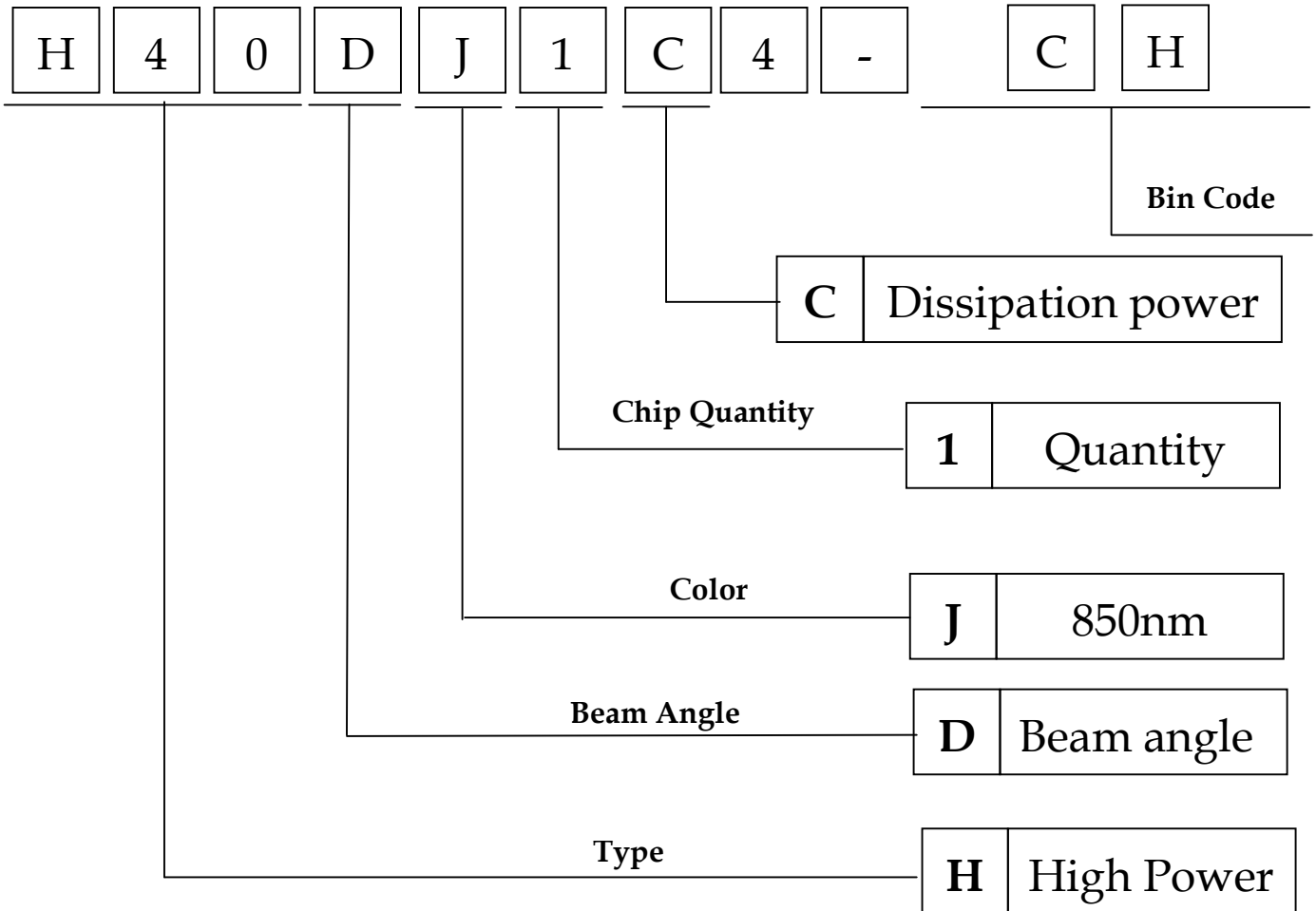

Characteristic Diagram

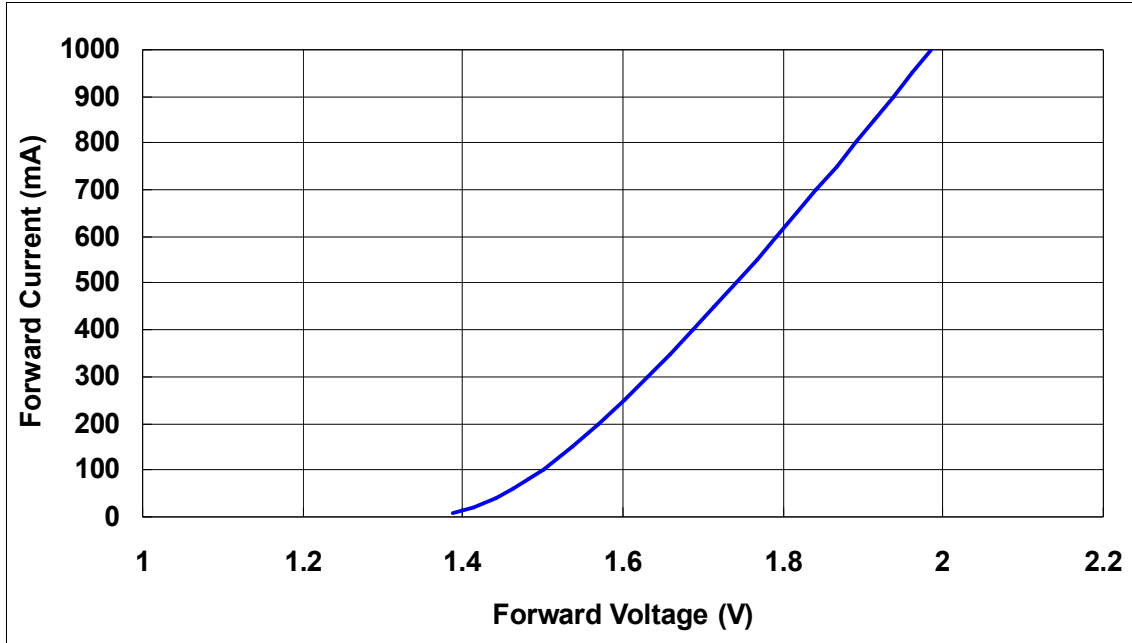

Fig. Forward Current vs. Forward Voltage

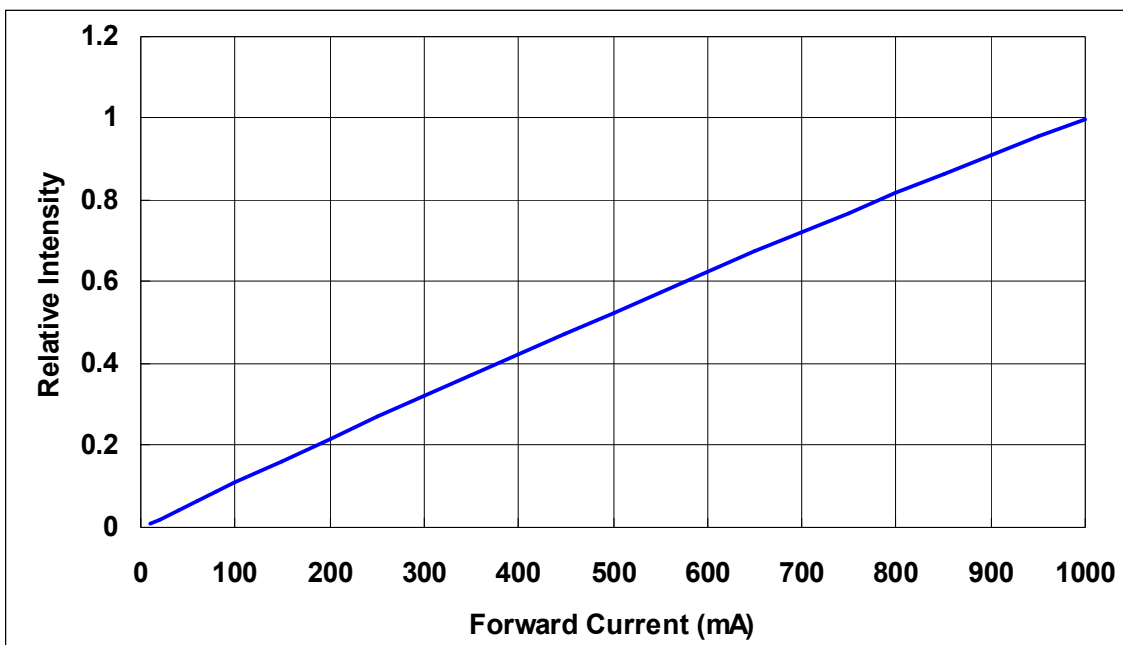

Fig. Relative Intensity vs. Forward Current.

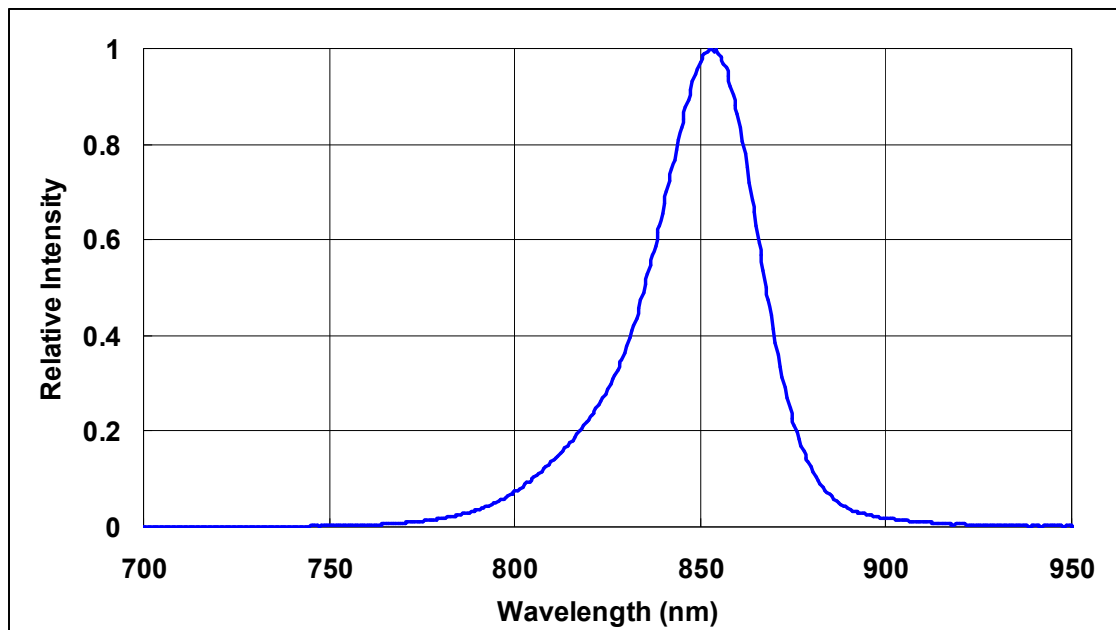

Fig. Typical Relative Intensity vs. wavelength

Outline Dimension

Unit : mm

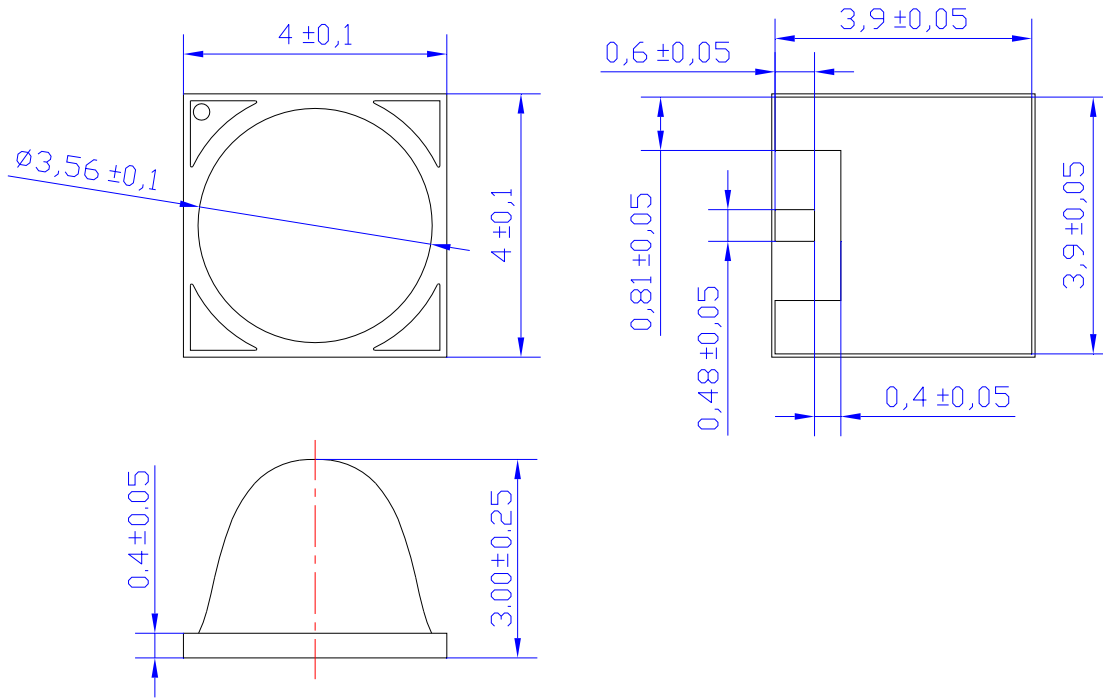
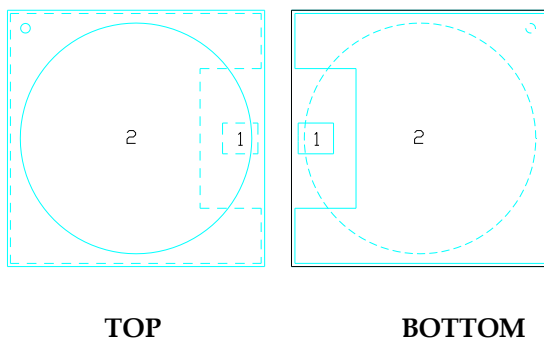

Fig. Package Outline Drawing.

● Pad Configuration



PAD	Function
1	Cathode
2	Anode、Thermal

Fig. Pad configuration.

Note: Please don't put conductive material on the top surface of LEDs.

HPL-H40XJ1C4

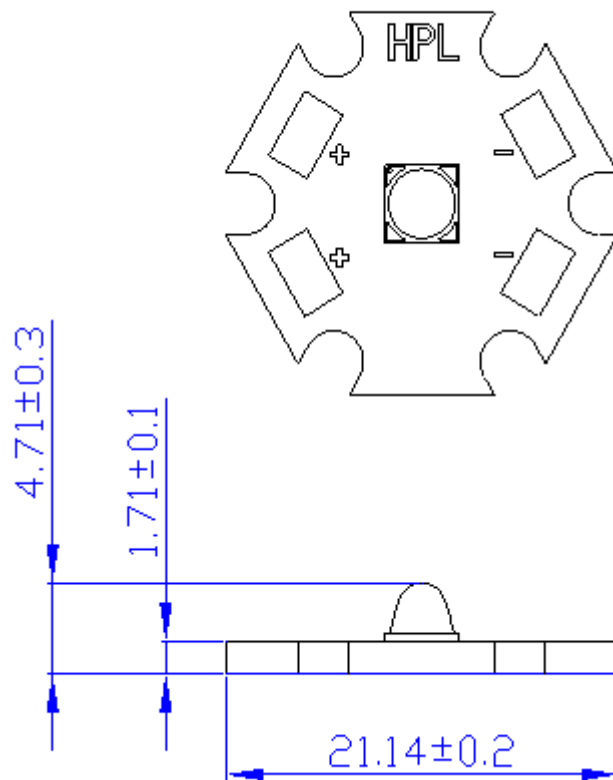
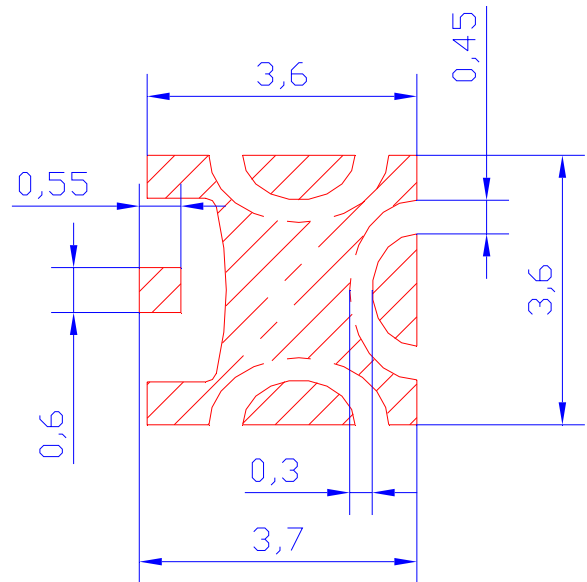
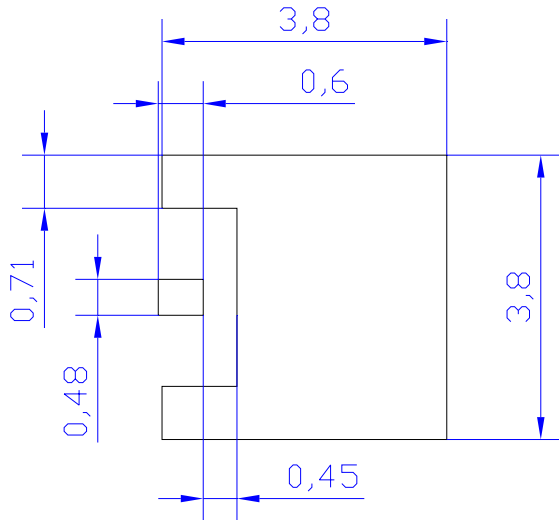

Fig. Assembly Outline Drawing.

Recommended Solder Pattern

Unit : mm

Tolerance±0.05



MCPCB LAYOUT

SOLDER MASK

Fig. Solder Pad Layout.

Shipping Package Style

Tapping Dimension Packaging Specification

- Moisture proof bag.
- 1 Reel/bag.
- Q'ty : 700(MAX) / 7 inch Reel
- Q'ty : 2500(MAX) / 13 inch Reel

Unit : mm

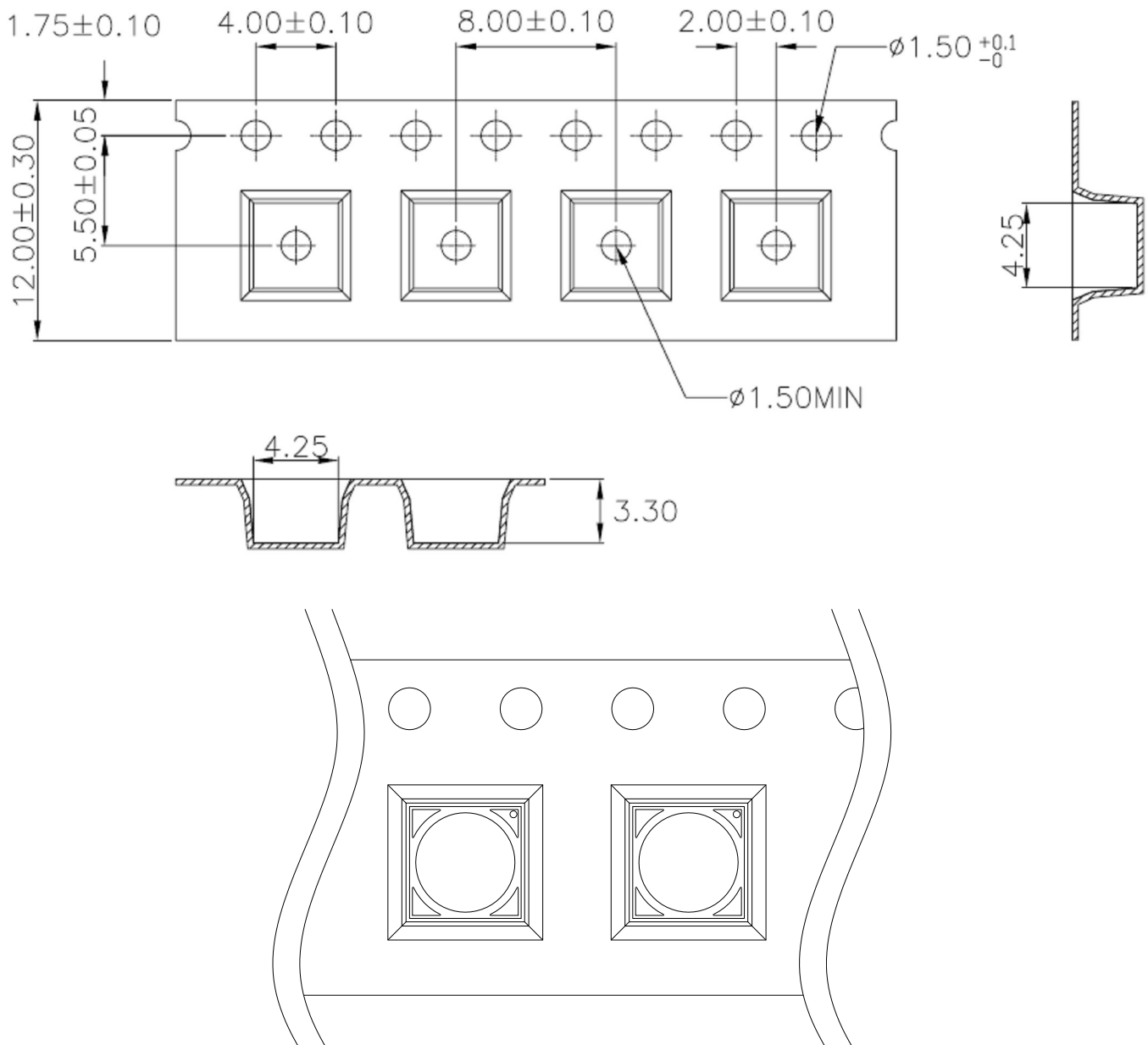

7 inch Reel Package

Box Type	Dimension (mm)	Reel/Box	40°Lens Type (Pcs)
Small Box(S)	230x85x265	5 Reel/Box	3500
Middle Box(M)	470x265x270	30 Reel/Box	21000
Large Box(L)	470x435x270	50 Reel/Box	35000

Reel Packaging :

Reel Part :

Unit : mm

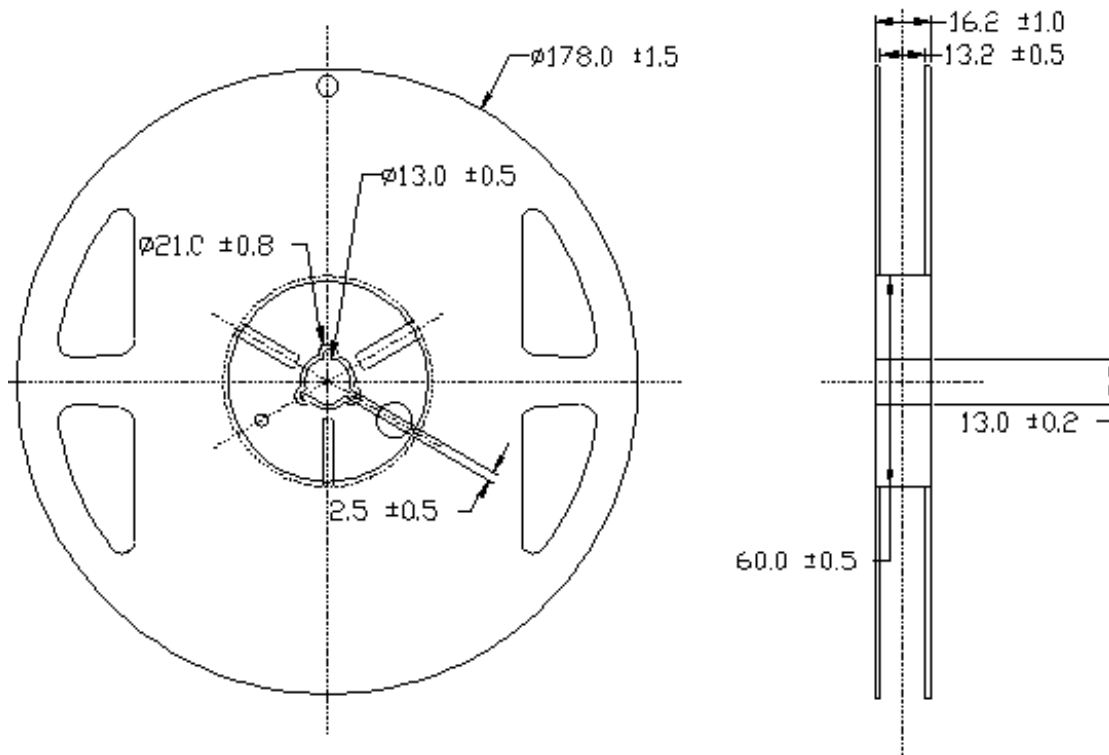

Anti Statistic Bag :

Unit : mm

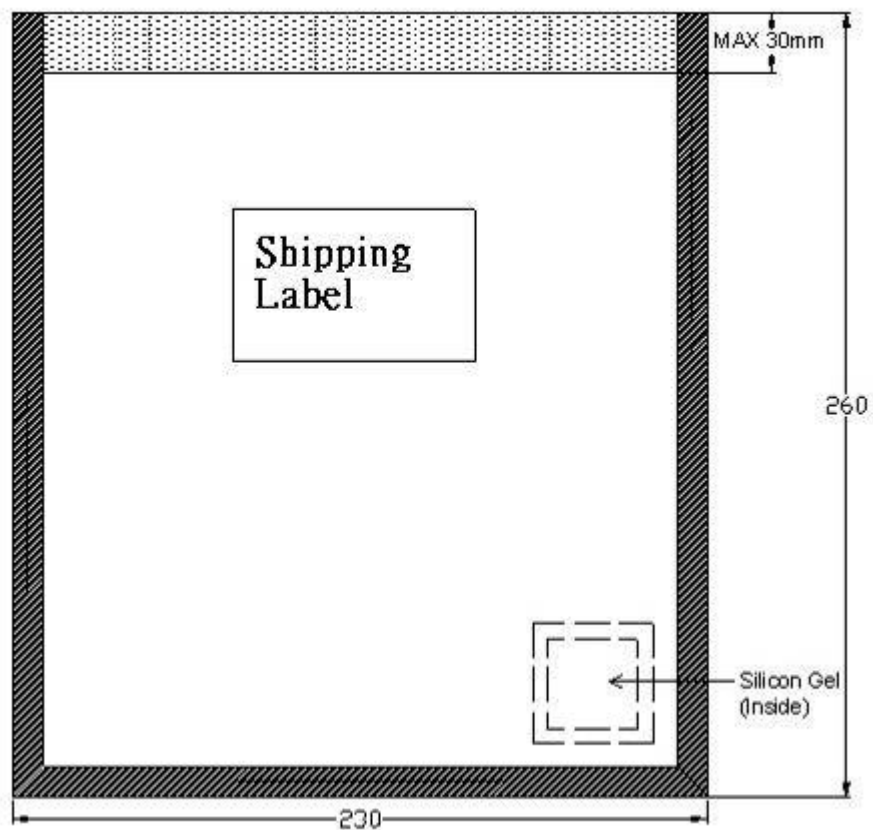

Small Box

Unit : mm

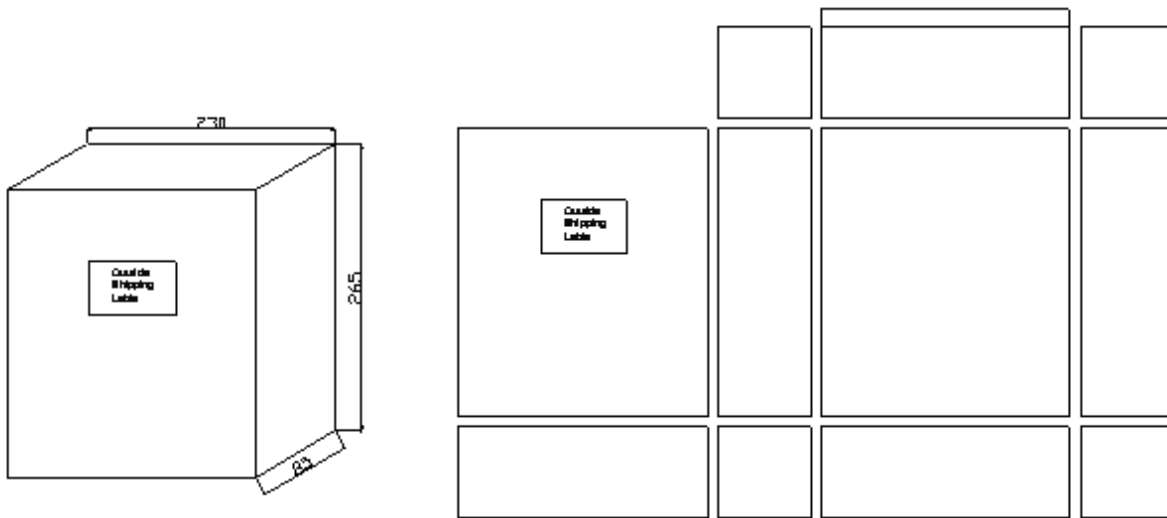

Middle Box

Unit : mm

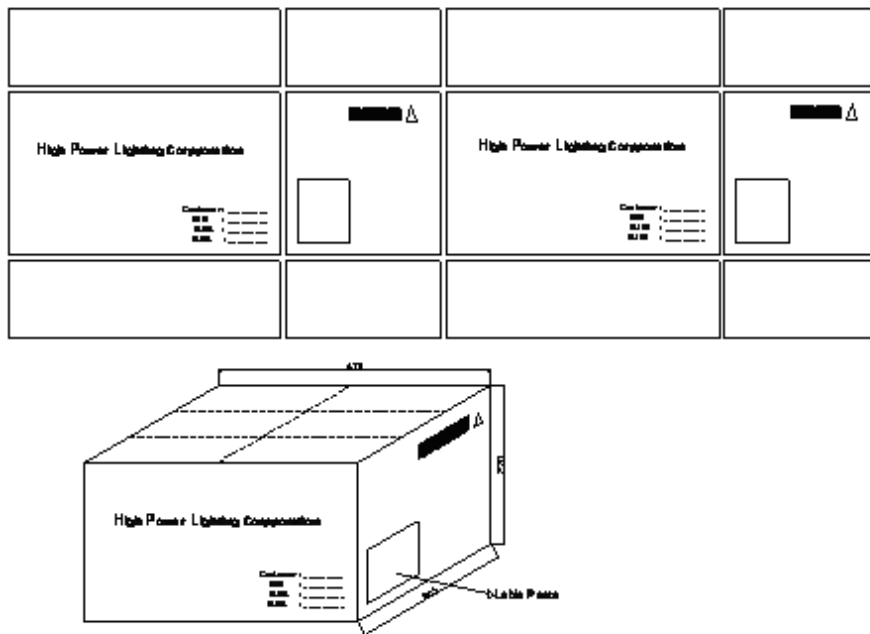

Large Box

Unit : mm

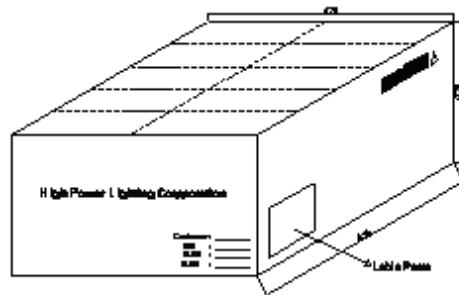
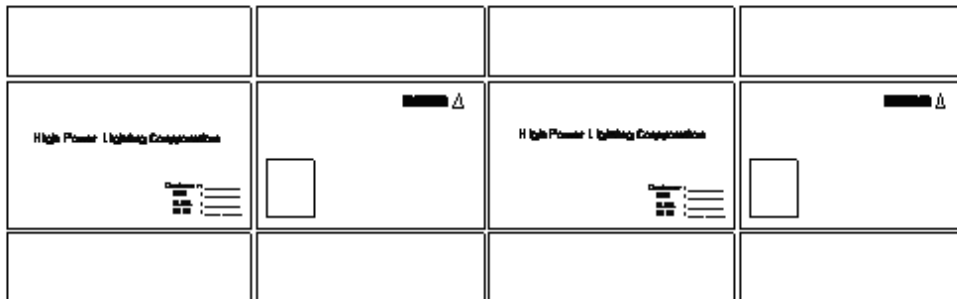

Label Formation

Unit : mm

70mm

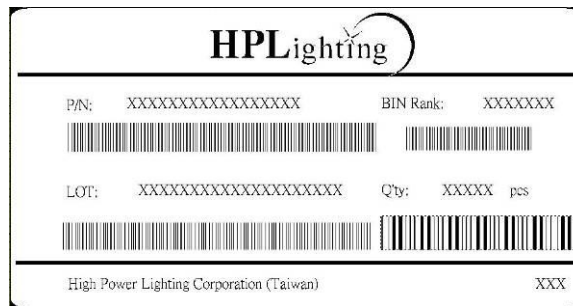

40mm

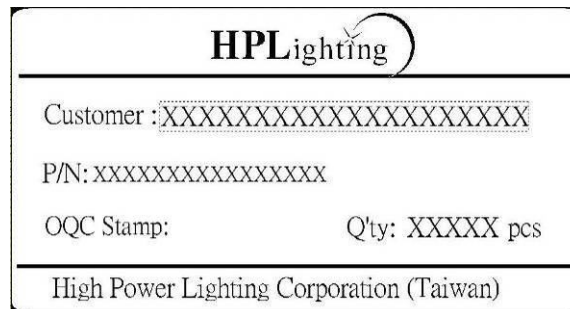

13 inch Reel Package

Box Type	Dimension (mm)	Reel/Box	40°Lens Type (Pcs)
Small Box(S)	415 x 380 x 95	5 Reel/Box	12500
Middle Box(M)	415 x 380 x 290	15 Reel/Box	37500
Large Box(L)	780 x 432 x 310	30 Reel/Box	75000

Reel Packaging :

Reel Part :

Unit : mm

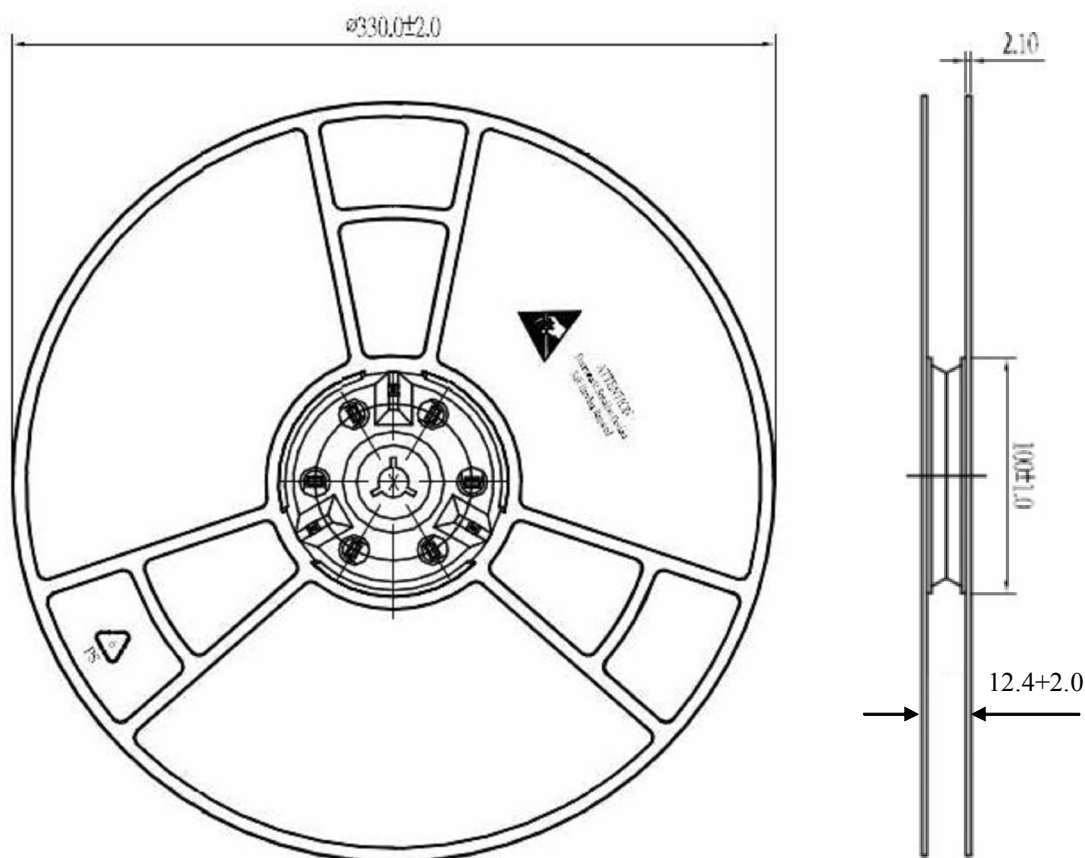

Anti Statistic Bag :

Unit : mm

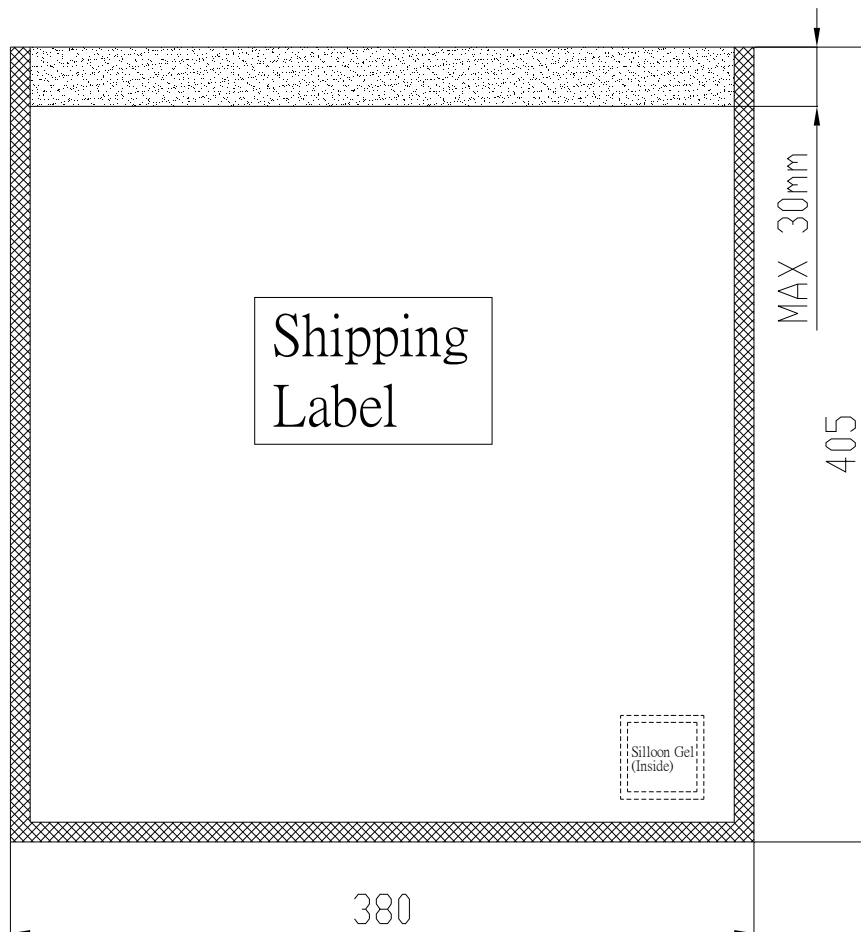

Small Box

Unit : mm

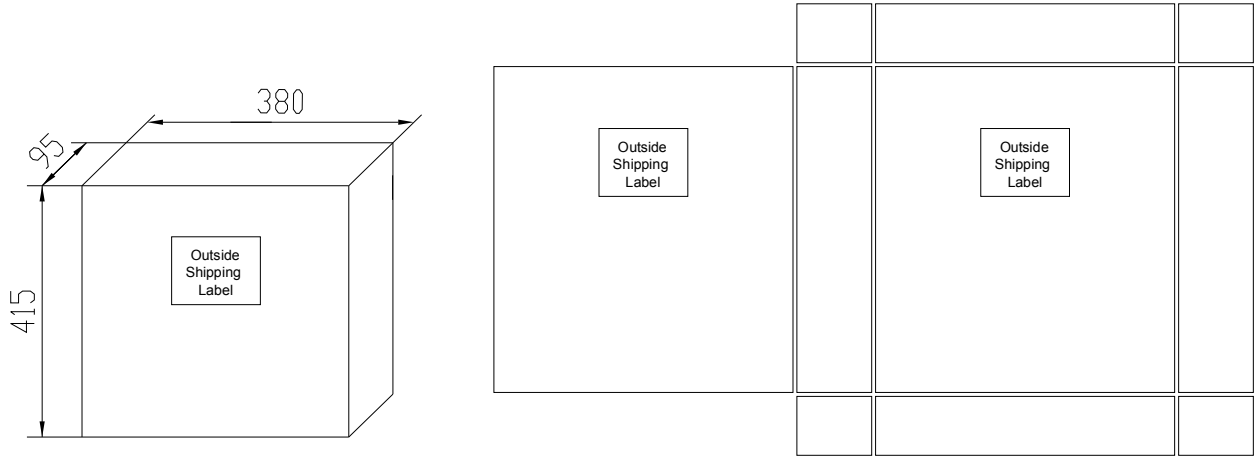

Middle Box

Unit : mm

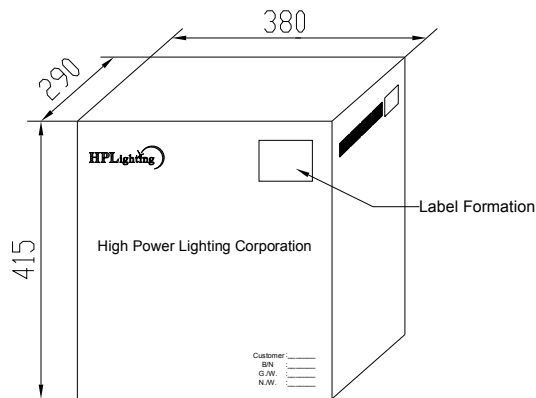
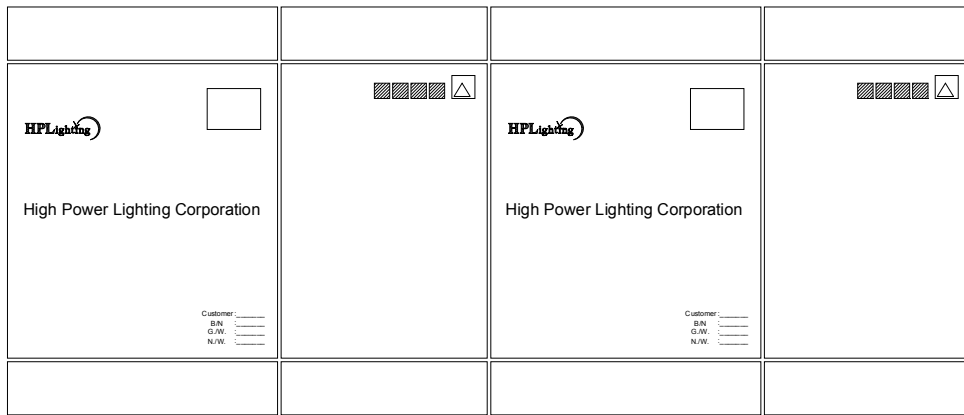



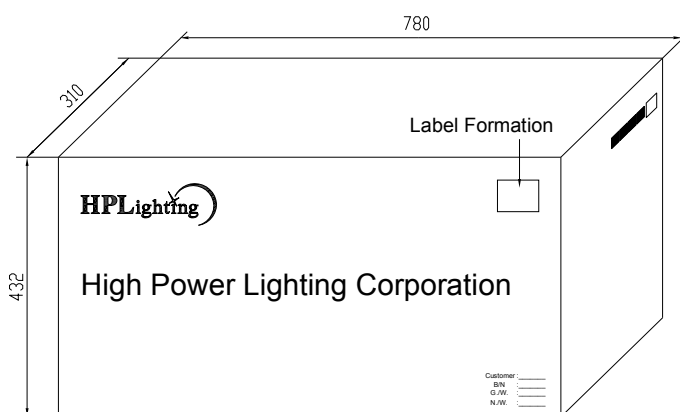
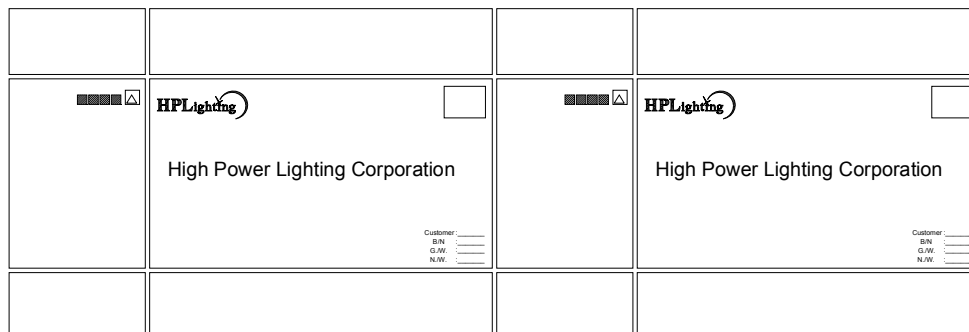

Large Box

Unit : mm

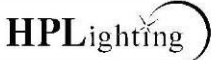

Label Formation

70mm

	
P/N: XXXXXXXXXXXXXXXXX	BIN Rank: XXXXXXX
	
LOT: XXXXXXXXXXXXXXXXXXXX	Q'ty: XXXXX pcs
	
High Power Lighting Corporation (Taiwan)	XXX

40mm

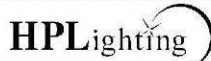
	
Customer :XXXXXXXXXXXXXXXXXXXXXX	
P/N: XXXXXXXXXXXXXXXXX	
OQC Stamp:	Q'ty: XXXXX pcs
High Power Lighting Corporation (Taiwan)	

Qualification Reliability Testing

Classification	Test Item	Test conditions	Reference Standard
Endurance Test	Operation Life	$I_F = 1000\text{mA}$ $T_a = 25^\circ\text{C}$ Test Duration = 1000hrs	MIL-STD-750: 1026 MIL-STD-883: 1005 JIS C 7021: B-1
	High Temperature High Humidity Storage	$T_a = 85\pm 5^\circ\text{C}$ RH = 85±5% Test Duration = 1000hrs	MIL-STD-202: 103B JIS C 7021: B-11
	High Temperature Storage	$T_a = 105\pm 5^\circ\text{C}$ Test Duration = 1000hrs	MIL-STD-202: 1008 JIS C 7021: B10
	Low Temperature Storage	$T_a = -40\pm 5^\circ\text{C}$ Test Duration = 1000hrs	JIS C 7021: B-12
Environmental Test	Temperature Cycling	$-30^\circ\text{C} \sim 25^\circ\text{C} \sim 105^\circ\text{C} \sim 25^\circ\text{C}$ 30min 5min 30min 5min Test Duration = 10 cycle	MIL-STD-202: 107D MIL-STD-750: 1051 MIL-STD-883: 1010 JIS C 7021: A-4
	Thermal Shock	$-30\pm 5^\circ\text{C} \sim 105\pm 5^\circ\text{C}$ 30min 30min Test Duration = 10 cycle	MIL-STD-202: 107D MIL-STD-750: 1051 MIL-STD-883: 1011
	Solder Resistance	$T_{sol} = 260\pm 5^\circ\text{C}$ Dwell Time = 10sec	MIL-STD-202: 210A MIL-STD-750: 2031 JIS C 7021: A-1

Measuring Items	Symbol	Measuring Conditions	Failure Criteria
Forward voltage	V_F	$I_F = 1000\text{mA}$	V_F shift > 10%
Luminous	$I_v\%$	$I_F = 1000\text{mA}$	$I_v\%$ shift > 10%

Recommended Solder Profile

Soldering Recommended soldering conditions:

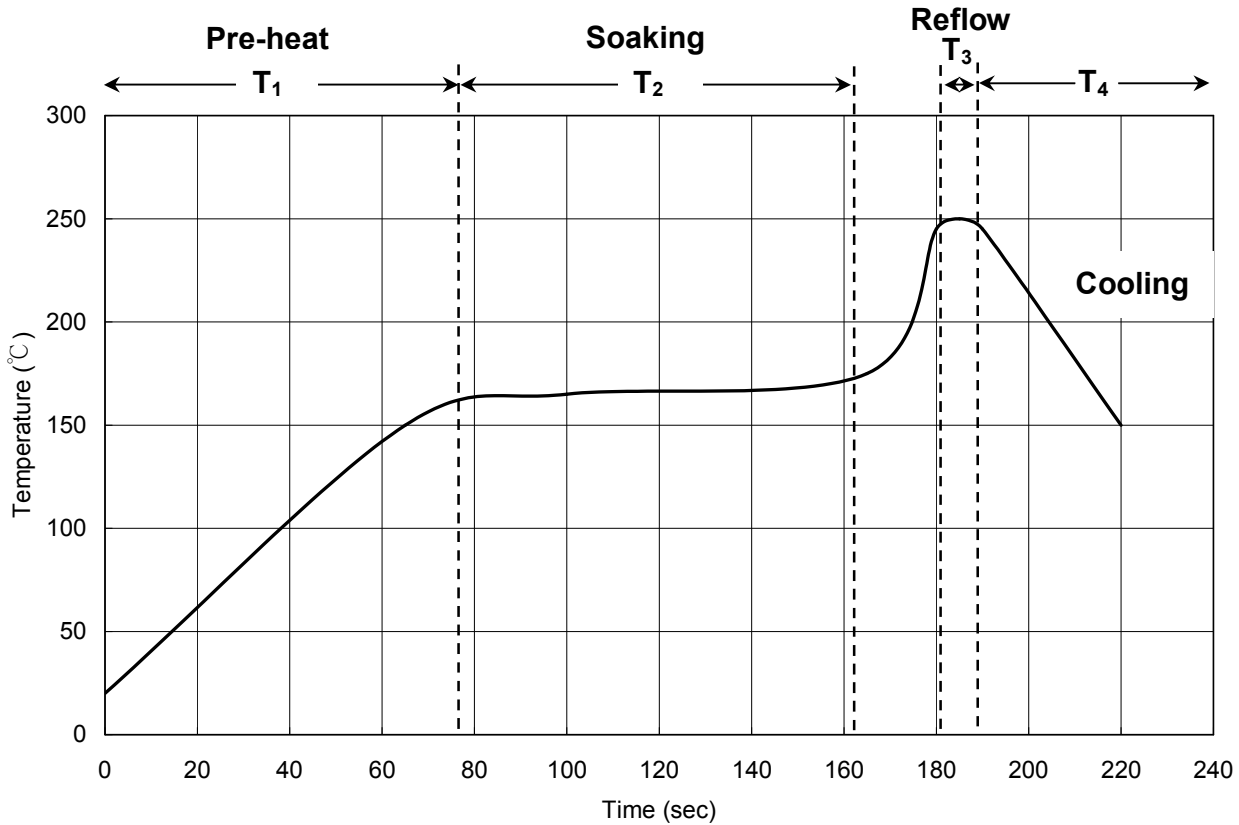

T ₁	Ramp up rate	1.0 ~ 3.0 °C/sec
	Pre-heat time	50 ~ 80 sec
T ₂	Soaking temperature	155 ~ 185 °C
	Dwell time during soaking	60 ~ 120 sec
T ₃	Reflow temperature	240 ~ 250 °C
	Reflow time	Max 10 sec
	Ramp up rate during reflow	1.2 ~ 2.3 °C/sec
T ₄	Cooling	1.0 ~ 6.0 °C/sec

Note: Suggest using Sn96Ag3Cu0.5 lead free solder.

Cleaning

Use alcohol-based cleaning solvents such as isopropyl alcohol to clean the LED if necessary.



This page is intended left blank.

For the latest product information, call us or visit: www.hplighting.com.tw

©2015, High Power Lighting Corporation(HPL), all rights reserved. This document contains information that is proprietary to HPL and may be duplicated in whole or in part by the original recipient for the internal business purposes only, provided that this entire notice appears in all copies. In accepting this document, the recipient agrees to make every reasonable effort to prevent unauthorized use of this information.

5F, No 173-8, Yung-Fon Road, Tu-Cheng District, New Taipei City, Taiwan, R.O.C.
TEL: +886-2-8262-8886 FAX : +886-2-8262-8885

HPLighting Corp.

www.hplighting.com.tw